

SWING CHECK VALVES

PRESSURE SEAL COVER

SW/CH CLASS 900

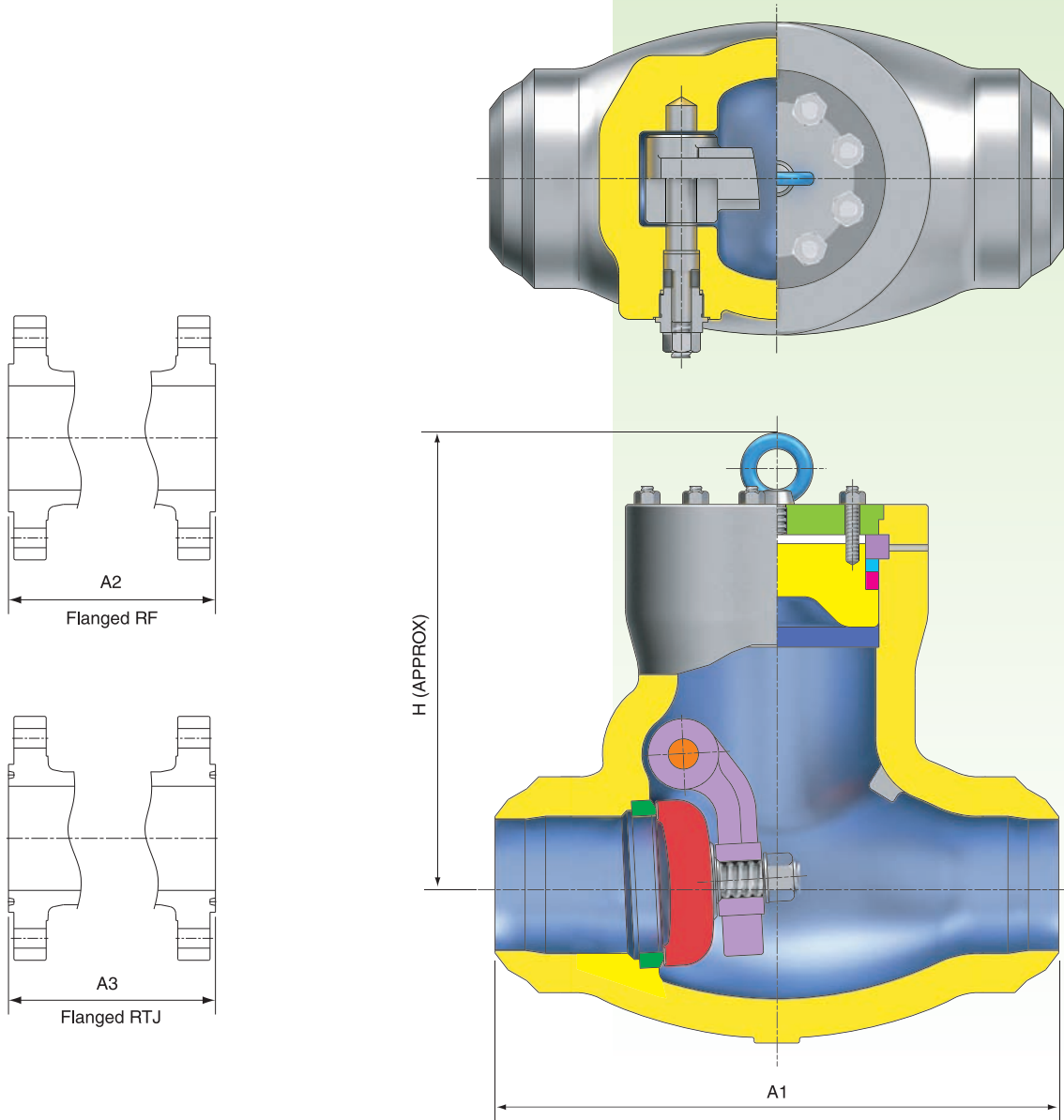

VALVE SIZE	in	2	2.5	3	4	6	8	10	12	14	16	18	20	24	
	mm	50	65	80	100	150	200	250	300	350	400	450	500	600	
A1	in	14.5	16.5	12.0	14.0	20.0	26.0	31.0	36.0	39.0	43.0	46.5	50.5	59.5	
	mm	368	419	305	356	508	660	787	914	991	1092	1181	1283	1511	
A2	in	14.5	16.5	15.0	18.0	24.0	29.0	33.0	38.0	40.5	44.5	48.0	52.0	61.0	
	mm	368	419	381	457	610	737	838	965	1029	1130	1219	1321	1549	
A3	in	14.6	16.6	15.1	18.1	24.1	29.1	33.1	38.1	40.9	44.9	48.5	52.5	61.7	
	mm	371	422	384	460	613	740	841	968	1039	1140	1232	1334	1568	
H	in	11.4	13.5	8.1	15.0	15.9	23.1	23.9	27.4	29.5	28.7	33.5	34.0	37.8	
	mm	289	343	205	381	403	587	606	695	749	730	851	864	959	
WEIGHT	RF	lb	88.2	121.3	114.6	231.5	507.1	1256.6	1873.9	2866.0	3417.1	3637.6	5070.6	6613.8	9038.8
		kg	40	55	52	105	230	570	850	1300	1550	1650	2300	3000	4100
	BW	lb	44.1	70.5	66.1	143.3	352.7	970.0	1521.2	2248.7	2645.5	2976.2	4078.5	5291.0	6393.3
		kg	20	32	30	65	160	440	690	1020	1200	1350	1850	2400	2900