



Electronic Wire & Cable



Head Office
19~21F ASEM Tower, 159 Samsung-dong,
Gangnam-gu, Seoul 135-090, Korea
Tel : (82-2) 2189-9340~4
Fax : (82-2) 2189-9349

Electronic Wire & Cable

Electronic Wire & Cable
Electronic Wire & Cable



➤➤➤➤ **Electronic Wire & Cable**

Electronic Wire & Cable



New Dream, New Start

To become a leader in the competitive global market, LG has been divided into three groups, electronics and chemicals for LG, energy and distribution for GS, Industrial electric·electronics and material for LS based on their business specialties.

LS, led by John Koo(former CEO of LG Electronics), has 17 companies with LS Cable as our flagship company. LS is the 15th largest conglomerate with \$5.7 billion asset and \$8.7 billion sales in 2004.

LS' main companies, such as LS Cable, LS industrial systems, LS-Nikko copper, Gaon cable, E1 and Kukdong City Gas, are ranked as No.1 in their respective industry. However, LS won't just sit back, satisfied with being the best in Korea. We will pave the way for becoming the world's best in industrial electric·electronics and material industry with the new CI, LS.



CONTENTS

Lead Wire

UL1007	TR-64	1-1	Lead Free Heat-resistant PVC insulated wire	6
UL1015	TEW	1-2	Lead Free Heat-resistant PVC insulated wire	7
UL10272	AWM	1-3	Lead Free Heat-resistant PVC insulated wire	8
UL1032	TR-32	1-4	Lead Free Heat-resistant PVC insulated wire	9
UL1061	AWM	1-5	Lead Free Heat-resistant semi-rigid PVC insulated wire	10
UL1275, 1276	AWM	1-6	Lead Free Heat-resistant PVC insulated wire	11
UL1283, 1284	TEW	1-7	Lead Free Heat-resistant PVC insulated wire	12
UL1316, 1452	TR-64	1-8	Lead Free Heat-resistant PVC insulated, Nylon sheath wire	13
UL1569	TR-64	1-9	Lead Free Heat-resistant PVC insulated wire	14
UL1571		1-10	Lead Free PVC insulated wire	15
UL1617	TEW	1-11	Lead Free Heat-resistant PVC double-insulated wire	16
UL1618		1-12	Lead Free Heat-resistant PVC double-insulated wire	17

Irradiated Wire

UL1429	AWM	2-1	Lead Free Irradiated XLPVC insulated wire	18
UL1430	REW(XLPVC)	2-2	Lead Free Irradiated XLPVC insulated wire	19
UL1431	REW(XLPVC)	2-3	Lead Free Irradiated XLPVC insulated wire	20
UL3443		2-4	Lead Free Irradiated XLPVC insulated wire	21
UL1672	AWM	2-5	Lead Free Irradiated XLPVC double-insulated wire	22
UL1673		2-6	Lead Free Irradiated XLPVC double-insulated wire	23
UL3265		2-7	Lead Free Heat-resistant irradiated XLPE insulated wire	24
UL3266	CL1252/AWM	2-8	Lead Free Heat-resistant irradiated XLPE insulated wire	25
UL3173	CL1251	2-9	Lead Free Heat-resistant irradiated XLPE insulated wire	26
UL3271	CL1251	2-10	Lead Free Heat-resistant irradiated XLPE insulated wire	27
UL3321	AWM	2-11	Lead Free Heat-resistant irradiated XLPE insulated wire	28
UL3398	CL1252/AWM	2-12	Lead Free Heat-resistant irradiated XLPE insulated wire	29
UL3239 (3kV, 6kV)		2-13	Lead Free Flexible high voltage wire	30
UL3633, 3613		2-14	Lead Free Flexible high voltage wire	31

Halogen Free Irradiated Wire

UL10368		3-1	Halogen Free Heat-resistant irradiated XLPE insulated wire	32
UL3275		3-2	Halogen Free Heat-resistant irradiated XLPE insulated wire	33
UL3302		3-3	Halogen Free Heat-resistant irradiated XLPE insulated wire	34
UL3385		3-4	Halogen Free Heat-resistant irradiated XLPE insulated wire	35
UL3386		3-5	Halogen Free Heat-resistant irradiated XLPE insulated wire	36
UL3619		3-6	Halogen Free Heat-resistant irradiated XLPE insulated wire	37

CONTENTS

High Voltage TV Wire

UL3239	TV-10~50	4-1	Lead Free high voltage wire for TV	38
UL3476	TV-6	4-2	Lead Free high voltage wire for TV (Single insulation type)	39

Fluoropolymer Wire

UL1422		5-1	Fluoropolymer (PVdF) insulation wire	40
UL1426		5-2	Fluoropolymer (PVdF) insulation wire	41
UL1508		5-3	Fluoropolymer (ETFE) insulation wire	42
UL1516		5-4	Fluoropolymer (ETFE) insulation wire	43
UL1517		5-5	Fluoropolymer (ETFE) insulation wire	44
UL1610		5-6	Fluoropolymer (ETFE) insulation wire	45
UL10086		5-7	Fluoropolymer (ETFE) insulation wire	46
UL10109		5-8	Fluoropolymer (ETFE) insulation wire	47
UL1330		5-9	Fluoropolymer (FEP) insulation wire	48
UL1331		5-10	Fluoropolymer (FEP) insulation wire	49
UL1332	AWM	5-11	Fluoropolymer (FEP) insulation wire	50
UL1333	AWM	5-12	Fluoropolymer (FEP) insulation wire	51
UL1709		5-13	Fluoropolymer (PFA) insulation wire	52
UL1710		5-14	Fluoropolymer (PFA) insulation wire	53
UL1726		5-15	Fluoropolymer (PFA) insulation wire	54
UL1860		5-16	Fluoropolymer (PFA) insulation wire	55

Appendix

A-1	UL & CSA Standards, UL & CSA Certificate Labels	56
A-2	Marking of UL & CSA Approved Wires, Definition of UL Style Numbers	57
A-3	Restrictions on the use of UL & CSA Approved Wires	58
A-4	Registration in Accordance with JQA Equipment Inflammability (-F- Mark)	59
A-5	Construction of Stranded Conductors	60
A-6~7	General Characteristics of Insulation Materials	61
A-8	Oil and Solvent Resistance of Plastic and Rubber Materials	63
A-9	Migration of Plastic and Rubber Materials	64
A-10	Shield Effect of Various Shielded Wires for Electronic Appliance	65
A-11~14	Electrical Characteristics Calculation Formulations	66
A-15~17	Allowable Current Calculation Formulations	70
A-18~19	AWG \leftrightarrow mm Conversion Table of Wire Gauges	73
A-20~22	Unit Conversion Table	75

1-1 Lead Wire

Lead Free Heat-resistant PVC insulated wire

UL Style No.1007 CSA Type TR-64

- Rating UL : 300V, 80°C / CSA : 300V (Peak 600V), 90°C
- Standard UL : UL Subject 758 / CSA : CSA C22.2 NO.127

Application

Internal wiring of electrical and electronic equipments (Secondary circuits lead wire).

Features

1. Standard : For both UL and CSA
2. Flame retardant : UL VW-1, CSA FT1, Material Control Law -F-
3. EU Directive RoHS : Restricted use of Pb, Cd, Hg, Cr+6, PBBs, PBDEs

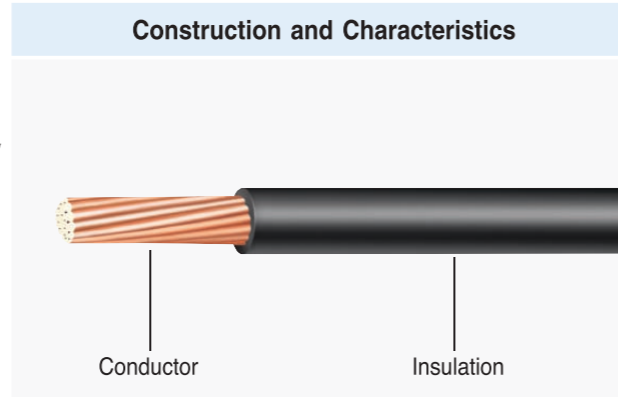

Marking

1007 E52853 VW-1  AWM LL33908 CSA TR-64 90C FT1 AWG NO. LS Cable -F- LF

Type	Conductor			Insulation		Max. Cond. Resistance (20°C) (Ω/km)	Min. Insulation Resistance (15.6°C) (MΩ·km)	Dielectric Strength (AC) (V/1min)	Allowable Current (reference) (A)	Unit Length (m) (ft)
	Size (AWG)	Construction (No./mm)	Diameter (mm)	Nominal Thickness (mm)	Diameter (mm)					
Stranded	30	7/0.102	0.31	0.40	1.11	381.00	10	2,000	2.3	610(2,000)
	28	7/0.127	0.38	0.40	1.18	239.00	10	2,000	3.0	610(2,000)
	26	7/0.160	0.48	0.40	1.28	150.00	10	2,000	4.0	610(2,000)
	24	11/0.160	0.61	0.40	1.41	94.20	10	2,000	5.3	610(2,000)
	22	17/0.160	0.76	0.40	1.56	59.40	10	2,000	7.2	610(2,000)
	20	26/0.160	0.94	0.40	1.74	36.70	10	2,000	9.4	610(2,000)
	18	41/0.160	1.18	0.40	1.98	23.20	10	2,000	12.5	305(1,000)
	16	26/0.254	1.49	0.40	2.29	14.60	10	2,000	15.9	305(1,000)
Solid	30	1/0.254	0.26	0.40	1.06	361.00	10	2,000	2.3	610(2,000)
	28	1/0.320	0.32	0.40	1.12	227.00	10	2,000	3.0	610(2,000)
	26	1/0.404	0.40	0.40	1.20	143.00	10	2,000	4.0	610(2,000)
	24	1/0.511	0.51	0.40	1.31	89.30	10	2,000	5.3	610(2,000)
	22	1/0.643	0.64	0.40	1.44	56.40	10	2,000	7.2	610(2,000)
	20	1/0.813	0.81	0.40	1.61	35.20	10	2,000	9.4	610(2,000)
	18	1/1.024	1.02	0.40	1.82	22.20	10	2,000	12.5	305(1,000)
	16	1/1.290	1.29	0.40	2.09	14.00	10	2,000	15.9	305(1,000)
TA-SC	26	7/0.160	0.48	0.40	1.28	150.00	10	2,000	4.0	610(2,000)
	24	7/0.203	0.61	0.40	1.41	94.20	10	2,000	5.3	610(2,000)
	22	7/0.254	0.76	0.40	1.56	59.40	10	2,000	7.2	610(2,000)

- Remarks 1) Size range : UL 32-16AWG, CSA 28-16AWG
2) Allowable current : Ambient temperature 40°C, Max. allowable temperature 80°C, single-wire in air

1-2 Lead Wire

Lead Free Heat-resistant PVC insulated wire

UL Style No.1015 CSA Type TEW

- Rating UL : 600V, 105°C / CSA : 600V, 105°C
- Standard UL : UL Subject 758 / CSA : CSA C22.2 NO.127

Application

Internal wiring of electrical and electronic equipments (Primary circuits lead wire).

Features

1. Standard : For both UL and CSA
2. Flame retardant : UL VW-1, CSA FT1, Material Control Law -F-
3. EU Directive RoHS : Restricted use of Pb, Cd, Hg, Cr+6, PBBs, PBDEs

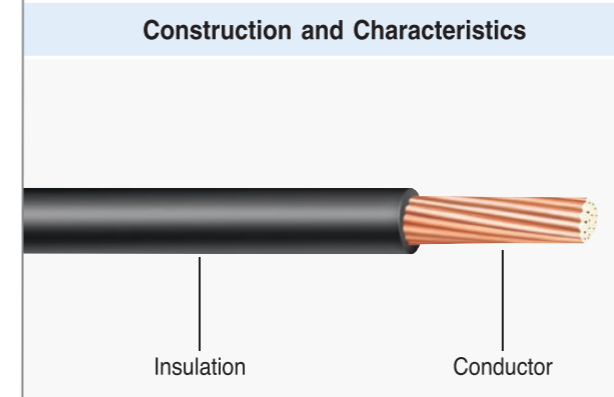

Marking

1015 E52853 VW-1  AWM 105C LL33911 CSA TEW 105C 600V FT1 AWG NO. LS Cable -F- LF

Type	Conductor			Insulation		Max. Cond. Resistance (20°C) (Ω/km)	Min. Insulation Resistance (15.6°C) (MΩ·km)	Dielectric Strength (AC) (V/1min)	Allowable Current (reference) (A)	Unit Length (m) (ft)
	Size (AWG)	Construction (No./mm)	Diameter (mm)	Nominal Thickness (mm)	Diameter (mm)					
Stranded	26	7/0.160	0.48	0.79	2.06	150.00	15	2,000	5.8	305(1,000)
	24	11/0.160	0.61	0.79	2.19	94.20	15	2,000	7.6	305(1,000)
	22	17/0.160	0.76	0.79	2.34	59.40	15	2,000	10.0	305(1,000)
	20	26/0.160	0.94	0.79	2.52	36.70	15	2,000	13.1	305(1,000)
	18	41/0.160	1.18	0.79	2.76	23.20	15	2,000	17.2	305(1,000)
	16	26/0.254	1.49	0.79	3.08	14.60	15	2,000	22.8	305(1,000)
	14	41/0.254	1.88	0.79	3.46	8.96	15	2,000	30.4	305(1,000)
	12	65/0.254	2.36	0.79	3.94	5.64	15	2,000	40.6	305(1,000)
	10	66/0.320	3.00	0.79	4.58	3.55	15	2,000	55.3	305(1,000)
	Solid	26	1/0.404	0.40	0.79	1.98	143.00	15	2,000	5.8
24		1/0.511	0.51	0.79	2.09	89.30	15	2,000	7.6	305(1,000)
22		1/0.643	0.64	0.79	2.22	56.40	15	2,000	10.0	305(1,000)
20		1/0.813	0.81	0.79	2.39	35.20	15	2,000	13.1	305(1,000)
18		1/1.024	1.02	0.79	2.60	22.20	15	2,000	17.2	305(1,000)
16		1/1.290	1.29	0.79	2.87	14.00	15	2,000	22.8	305(1,000)
14		1/1.630	1.63	0.79	3.21	8.78	15	2,000	30.4	305(1,000)
12		1/2.050	2.05	0.79	3.63	5.53	15	2,000	40.6	305(1,000)
10		1/2.590	2.59	0.79	4.17	3.48	15	2,000	55.3	305(1,000)
TA-SC		24	7/0.203	0.61	0.79	2.19	94.20	15	2,000	7.6
	22	7/0.254	0.76	0.79	2.34	59.40	15	2,000	10.0	305(1,000)

- Remarks 1) Size range : UL 28-9AWG, CSA 26-4/0AWG
2) Allowable current : Ambient temperature 40°C, Max. allowable temperature 105°C, single-wire in air
3) UL1015 covers the construction and characteristics of UL1011 and UL1013, so use of UL1015 is recommended.

1-3 Lead Wire

Lead Free Heat-resistant PVC insulated wire

UL Style No.10272 CSA Type AWM

- Rating UL : 150V, 80°C / CSA : 150V, 80°C
- Standard UL : UL Subject 758 / CSA : CSA C22.2 NO.127

Application

Internal wiring of electrical and electronic equipments.

Features

1. Flame retardant : UL VW-1, CSA FT1, Material Control Law -F-
2. Small diameter saves space.
3. EU Directive RoHS : Restricted use of Pb, Cd, Hg, Cr+6, PBBs, PBDEs

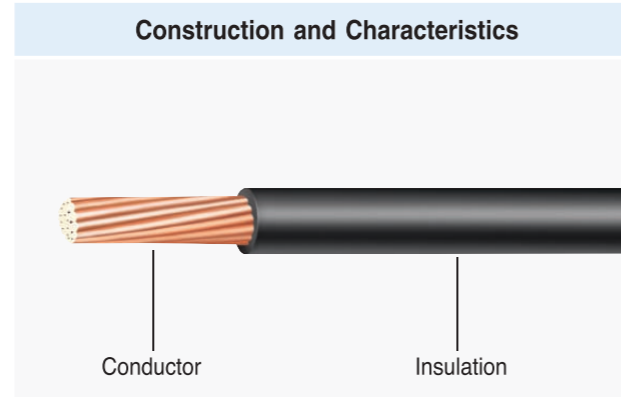

Marking

10272 E52853 VW-1  AWM I A 80C 150V FT1 AWG NO. LS Cable -F- LF

Type	Conductor			Insulation		Max. Cond. Resistance (20°C) (Ω/km)	Min. Insulation Resistance (15.6°C) (MΩ·km)	Dielectric Strength (AC) (V/1min)	Unit Length (m) (ft)
	Size (AWG)	Construction (No./mm)	Diameter (mm)	Nominal Thickness (mm)	Diameter (mm)				
Stranded	26	7/0.160	0.48	0.20	0.88	150.00	10	1,500	1,220(4,000)
	24	11/0.160	0.61	0.20	1.01	94.20	10	1,500	610(2,000)

► Remarks 1) Size range : UL 36-20AWG

1-4 Lead Wire

Lead Free Heat-resistant PVC insulated wire

UL Style No.1032 CSA Type TR-32

- Rating UL : 1,000Vac (1,200Vdc), 90°C / CSA : 1,400V (Peak), 90°C
- Standard UL : UL Subject 758 / CSA : CSA C22.2 NO.127

Application

It is optimum as lead wire of high voltage circuit of TV receivers and other electronic equipments.

Features

1. Standard : For both UL and CSA
2. Flame retardant : UL VW-1, CSA FT1, Material Control Law -F-
3. EU Directive RoHS : Restricted use of Pb, Cd, Hg, Cr+6, PBBs, PBDEs

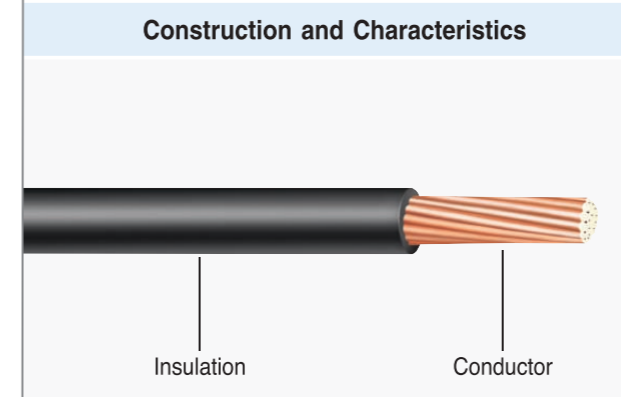

Marking

1032 E52853 VW-1  AWM 90C 1.2KVDC LL33908 CSA TR-32 FT1 90C AWG NO. LS Cable -F- LF

Type	Conductor			Insulation		Max. Cond. Resistance (20°C) (Ω/km)	Min. Insulation Resistance (15.6°C) (MΩ·km)	Dielectric Strength (AC) (V/1min)	Allowable Current (reference) (A)	Unit Length (m) (ft)
	Size (AWG)	Construction (No./mm)	Diameter (mm)	Nominal Thickness (mm)	Diameter (mm)					
Stranded	24	11/0.160	0.61	0.80	2.21	94.20	15	3,000	6.6	305(1,000)
	22	17/0.160	0.76	0.80	2.36	59.40	15	3,000	8.7	305(1,000)
	20	26/0.160	0.94	0.80	2.54	36.70	15	3,000	11.4	305(1,000)
	18	41/0.160	1.18	0.80	2.78	23.20	15	3,000	15.0	305(1,000)
	16	26/0.254	1.49	0.80	3.09	14.60	15	3,000	19.9	305(1,000)
	14	41/0.254	1.88	0.80	3.48	8.96	15	3,000	26.5	305(1,000)
	12	65/0.254	2.36	0.80	3.96	5.64	15	3,000	35.4	305(1,000)
	10	66/0.320	3.00	0.80	4.60	3.55	15	3,000	48.2	305(1,000)
Solid	24	1/0.511	0.51	0.80	2.11	89.30	15	3,000	6.6	305(1,000)
	22	1/0.643	0.64	0.80	2.24	56.40	15	3,000	8.7	305(1,000)
	20	1/0.813	0.81	0.80	2.41	35.20	15	3,000	11.4	305(1,000)
	18	1/1.024	1.02	0.80	2.62	22.20	15	3,000	15.0	305(1,000)
	16	1/1.290	1.29	0.80	2.89	14.00	15	3,000	19.9	305(1,000)
	14	1/1.630	1.63	0.80	3.23	8.78	15	3,000	26.5	305(1,000)
	12	1/2.050	2.05	0.80	3.65	5.53	15	3,000	35.4	305(1,000)
TA-SC	22	7/0.254	0.76	0.80	2.36	59.40	15	3,000	8.7	305(1,000)
	20	7/0.320	0.96	0.80	2.56	36.70	15	3,000	11.4	305(1,000)

► Remarks 1) Size range : UL 26-10AWG, CSA 24-10AWG

2) Allowable current : Ambient temperature 40°C, Max. allowable temperature 90°C, single-wire in air

1-5 Lead Wire

Lead Free Heat-resistant semi-rigid PVC insulated wire

UL Style No.1061 CSA Type AWM

- Rating UL : 300V, 80°C / CSA : 300V, 80°C
- Standard UL : UL Subject 758 / CSA : CSA C22.2 NO.210-2

Application

1. Internal wiring of electrical and electronic equipments.
2. Wiring of small equipment when space is a problem.

Features

1. Standard : For both UL and CSA
2. Flame retardant : UL VW-1, CSA FT1, Material Control Law -F-
3. Small outer diameter saves space.
4. EU Directive RoHS : Restricted use of Pb, Cd, Hg, Cr+6, PBBs, PBDEs

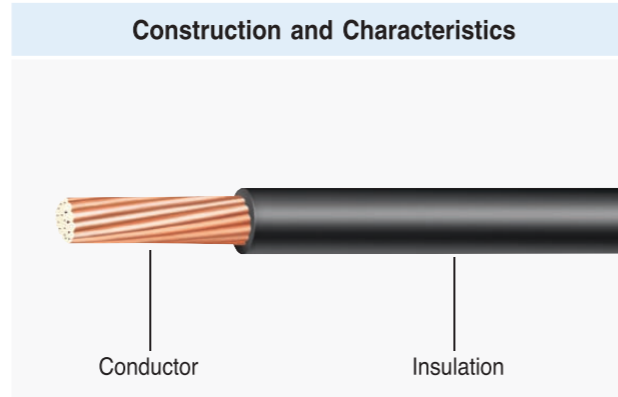

Marking

1061 E52853 VW-1 AWM LL57184 CSA AWM I A 80C 300V FT1 AWG NO. LS Cable -F- LF

Type	Conductor			Insulation		Max. Cond. Resistance (20°C) (Ω/km)	Min. Insulation Resistance (15.6°C) (MΩ·km)	Dielectric Strength (AC) (V/1min)	Allowable Current (reference) (A)	Unit Length (m) (ft)
	Size (AWG)	Construction (No./mm)	Diameter (mm)	Nominal Thickness (mm)	Diameter (mm)					
Stranded	30	7/0.102	0.31	0.25	0.81	381.00	10	2,000	2.0	1,220(4,000)
	28	7/0.127	0.38	0.25	0.88	239.00	10	2,000	2.6	1,220(4,000)
	26	7/0.160	0.48	0.25	0.98	150.00	10	2,000	3.4	1,220(4,000)
	24	11/0.160	0.61	0.25	1.11	94.20	10	2,000	4.6	610(2,000)
	22	17/0.160	0.76	0.25	1.26	59.40	10	2,000	6.1	610(2,000)
	20	26/0.160	0.94	0.25	1.44	36.70	10	2,000	8.4	610(2,000)
	18	41/0.160	1.18	0.30	1.78	23.20	10	2,000	11.3	610(2,000)
	16	26/0.254	1.49	0.30	2.09	14.60	10	2,000	15.2	305(1,000)
Solid	30	1/0.254	0.26	0.25	0.76	361.00	10	2,000	2.0	1,220(4,000)
	28	1/0.320	0.32	0.25	0.82	227.00	10	2,000	2.6	1,220(4,000)
	26	1/0.404	0.40	0.25	0.90	143.00	10	2,000	3.4	1,220(4,000)
	24	1/0.511	0.51	0.25	1.01	89.30	10	2,000	4.6	610(2,000)
	22	1/0.643	0.64	0.25	1.14	56.40	10	2,000	6.1	610(2,000)
	20	1/0.813	0.81	0.25	1.31	35.20	10	2,000	8.4	610(2,000)
	18	1/1.024	1.02	0.30	1.62	22.20	10	2,000	11.3	610(2,000)
	16	1/1.290	1.29	0.30	1.89	14.00	10	2,000	15.2	305(1,000)
TA-SC	28	7/0.127	0.38	0.25	0.88	239.00	10	2,000	2.6	1,220(4,000)
	26	7/0.160	0.48	0.25	0.98	150.00	10	2,000	3.4	1,220(4,000)
	24	7/0.203	0.61	0.25	1.11	94.20	10	2,000	5.6	610(2,000)
	22	7/0.254	0.76	0.25	1.26	59.40	10	2,000	6.1	610(2,000)

- Remarks 1) Size range : UL 30-16AWG, CSA 30-16AWG
2) Allowable current : Ambient temperature 40°C, Max. allowable temperature 80°C, single-wire in air

1-6 Lead Wire

Lead Free Heat-resistant PVC insulated wire

UL Style No.1275, 1276 CSA Type AWM

- Rating UL : 600V, 105°C / CSA : 600V, 105°C
- Standard UL : UL Subject 758 / CSA : CSA C22.2 NO.210-2

Application

Internal wiring of refrigerating and air-conditioning equipments.

Features

1. Standard : For both UL and CSA
2. Flame retardant : UL VW-1, CSA FT1, Material Control Law -F-
3. Marking Bunched stranded conductor is only possible.
4. Excellent Insulation resistance at high temperature and dielectric strength.
5. EU Directive RoHS : Restricted use of Pb, Cd, Hg, Cr+6, PBBs, PBDEs

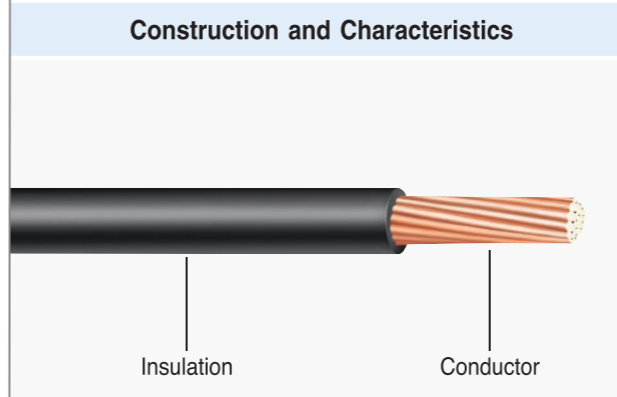

Marking

1275(1276) E52853 VW-1 AWM 105C LL57184 CSA AWM I A 105C 600V FT1 AWG NO. LS Cable -F- LF

UL Style	Conductor			Insulation		Max. Cond. Resistance (20°C) (Ω/km)	Min. Insulation Resistance (15.6°C) (MΩ·km)	Dielectric Strength (AC) (V/1min)	Unit Length (m) (ft)
	Size (AWG)	Construction (No./mm)	Diameter (mm)	Nominal Thickness (mm)	Diameter (mm)				
1275	18	41/0.160	1.18	1.60	4.38	23.20	93	2,000	305(1,000)
	16	26/0.254	1.49	1.60	4.69	14.60	83	2,000	305(1,000)
	14	41/0.254	1.88	1.60	5.08	8.96	72	2,000	305(1,000)
	12	65/0.254	2.36	1.60	5.56	5.64	61	2,000	305(1,000)
	10	66/0.320	3.00	1.60	6.20	3.55	54	2,000	305(1,000)
	1276	14	41/0.254	1.88	2.00	5.88	8.96	72	2,000
12		65/0.254	2.36	2.00	6.36	5.64	61	2,000	305(1,000)
10		66/0.320	3.00	2.00	7.00	3.55	54	2,000	305(1,000)

- Remarks 1) Size range : 1275 : UL 18-10AWG, 1276 : UL 14-10AWG, CSA 18-10AWG

1-7 Lead Wire

Lead Free Heat-resistant PVC insulated wire

UL Style No.1283,1284 CSA Type TEW

- Rating UL : 600V, 105°C / CSA : 600V, 105°C
- Standard UL : UL Subject 758 / CSA : CSA C22.2 NO.127

Application

Internal wiring of main electrical equipments requiring a large current, or for power circuits.

Features

1. Standard : For both UL and CSA
2. Flame retardant : UL VW-1, CSA FT1, Material Control Law -F-
3. EU Directive RoHS : Restricted use of Pb, Cd, Hg, Cr+6, PBBs, PBDEs

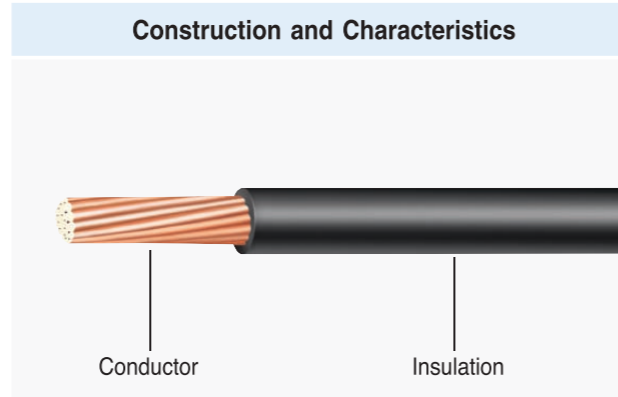

Marking

1283(1284) E52853 VW-1  AWM 105C LL33911 CSA TEW 105C FT1 AWG NO. LS Cable -F- LF

UL Style	Conductor			Insulation		Max. Cond. Resistance (20°C) (Ω/km)	Min. Insulation Resistance (15.6°C) (MΩ·km)	Dielectric Strength (AC) (V/1min)	Allowable Current (reference) (A)	Unit Length (m) (ft)
	Size (AWG)	Construction (No./mm)	Diameter (mm)	Nominal Thickness (mm)	Diameter (mm)					
1283	8	7/24/0.254	4.31	1.64	7.59	2.37	15	2,000	67.9	153(500)
	6	7/38/0.254	5.45	1.64	8.73	1.49	15	2,000	90.8	153(500)
	4	7/60/0.254	6.81	1.64	10.09	0.95	12	2,000	121.0	153(500)
	2	19/35/0.254	8.67	1.64	11.95	0.60	10	2,000	166.0	153(500)
1284	1	19/44/0.254	9.72	2.30	14.32	0.48	10	2,000	193.0	153(500)
	1/0	19/55/0.254	10.87	2.30	15.47	0.38	10	2,000	221.0	153(500)
	2/0	19/70/0.254	12.26	2.30	16.86	0.30	10	2,000	275.0	153(500)
	3/0	19/88/0.254	13.75	2.30	18.35	0.24	10	2,000	303.0	153(500)
4/0	37/57/0.254	15.40	2.35	20.10	0.19	10	2,000	353.0	153(500)	

- Remarks 1) Size range : 1283 : UL 8-2AWG, 1284 : UL 1-4/0AWG, CSA 8-4/0AWG
 2) Allowable current : Ambient temperature 40°C, Max. allowable temperature 105°C, single-wire in air
 3) UL1283 and UL1284 cover the construction and characteristics of UL1019 and UL1020, so use of UL1283 and UL1284 is recommended.

1-8 Lead Wire

Lead Free Heat-resistant PVC insulated, Nylon sheath wire

UL Style No.1316 or 1452 CSA Type TR-64

- Rating UL : 30V, 105°C or 1,000V, 90°C / CSA : 300V (Peak 600V), 90°C
- Standard UL : UL Subject 758 / CSA : CSA C22.2 NO.127

Application

Internal wiring of electrical and electronic equipments (Secondary circuits lead wire).

Features

1. Standard : For both UL and CSA
2. Excellent resistance to abrasion and hydrocarbons.
3. EU Directive RoHS : Restricted use of Pb, Cd, Hg, Cr+6, PBBs, PBDEs

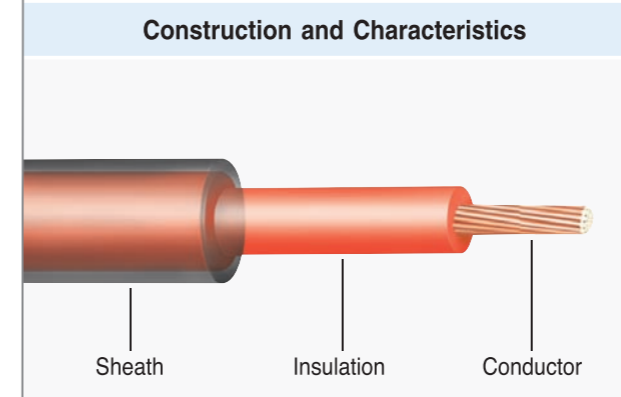

Marking

1316 105C 600V OR 1452 90C 1000V E52853  AWM LL33908 CSA TR-64 90C FT2 AWG NO. LS Cable LF

Type	Conductor			Insulation		Sheath		Max. Cond. Resistance (20°C) (Ω/km)	Min. Insulation Resistance (15.6°C) (MΩ·km)	Dielectric Strength (AC) (V/1min)	Unit Length (m) (ft)
	Size (AWG)	Construction (No./mm)	Diameter (mm)	Nominal Thickness (mm)	Diameter (mm)	Nominal Thickness (mm)	Diameter (mm)				
Stranded	24	11/0.160	0.61	0.38	1.37	0.12	1.61	94.20	15	2,000	610(2,000)
	22	17/0.160	0.76	0.38	1.52	0.12	1.76	59.40	15	2,000	610(2,000)
	20	26/0.160	0.94	0.38	1.70	0.12	1.94	36.70	15	2,000	610(2,000)
	18	41/0.160	1.18	0.38	1.94	0.12	2.18	23.20	15	2,000	305(1,000)
	16	26/0.254	1.49	0.38	2.25	0.12	2.49	14.60	15	2,000	305(1,000)
Solid	24	1/0.511	0.51	0.38	1.27	0.12	1.51	89.30	15	2,000	610(2,000)
	22	1/0.643	0.64	0.38	1.40	0.12	1.64	56.40	15	2,000	610(2,000)
	20	1/0.813	0.81	0.38	1.57	0.12	1.81	35.20	15	2,000	610(2,000)
	18	1/1.024	1.02	0.38	1.78	0.12	2.02	22.20	15	2,000	305(1,000)
	16	1/1.290	1.29	0.38	2.05	0.12	2.29	14.00	15	2,000	305(1,000)
TA-SC	26	7/0.160	0.48	0.38	1.24	0.12	1.48	150.00	15	2,000	610(2,000)
	24	7/0.203	0.61	0.38	1.37	0.12	1.61	94.20	15	2,000	610(2,000)
	22	7/0.254	0.76	0.38	1.52	0.12	1.76	59.40	15	2,000	610(2,000)

- Remarks 1) Size range : UL 26-12AWG, CSA 26-16AWG

1-9 Lead Wire

Lead Free Heat-resistant PVC insulated wire

UL Style No.1569 CSA Type TR-64

- Rating UL : 300V, 105°C / CSA : 300V, 105°C
- Standard UL : UL Subject 758 / CSA : CSA C22.2 NO.210-2

Application

Internal wiring of electrical and electronic equipments.
600 Volts peak for electronic use only.

Features

1. Standard : For both UL and CSA
2. Flame retardant : UL VW-1, CSA FT1, Material Control Law -F-
3. EU Directive RoHS : Restricted use of Pb, Cd, Hg, Cr+6, PBBs, PBDEs

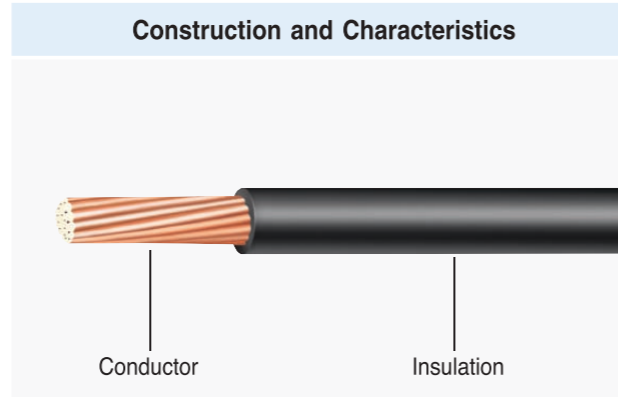

Marking

1569 E52853 VW-1 AWM 105C LL57184 CSA AWM I A 105C 300V FT1 AWG NO. LS Cable -F- LF

Type	Conductor			Insulation		Max. Cond. Resistance (20°C) (Ω/km)	Min. Insulation Resistance (15.6°C) (MΩ·km)	Dielectric Strength (AC) (V/1min)	Allowable Current (reference) (A)	Unit Length (m) (ft)
	Size (AWG)	Construction (No./mm)	Diameter (mm)	Nominal Thickness (mm)	Diameter (mm)					
Stranded	30	7/0.102	0.31	0.40	1.11	381.00	15	2,000	2.7	610(2,000)
	28	7/0.127	0.38	0.40	1.18	239.00	15	2,000	3.6	610(2,000)
	26	7/0.160	0.48	0.40	1.28	150.00	15	2,000	4.8	610(2,000)
	24	11/0.160	0.61	0.40	1.41	94.20	15	2,000	6.4	610(2,000)
	22	17/0.160	0.76	0.40	1.56	59.40	15	2,000	8.5	610(2,000)
	20	26/0.160	0.94	0.40	1.74	36.70	15	2,000	11.2	610(2,000)
	18	41/0.160	1.18	0.40	1.98	23.20	15	2,000	15.0	305(1,000)
	16	26/0.254	1.49	0.40	2.29	14.60	15	2,000	20.0	305(1,000)
Solid	30	1/0.254	0.26	0.40	1.06	361.00	15	2,000	2.7	610(2,000)
	28	1/0.320	0.32	0.40	1.12	227.00	15	2,000	3.6	610(2,000)
	26	1/0.404	0.40	0.40	1.20	143.00	15	2,000	4.8	610(2,000)
	24	1/0.511	0.51	0.40	1.31	89.30	15	2,000	6.4	610(2,000)
	22	1/0.643	0.64	0.40	1.44	56.40	15	2,000	8.5	610(2,000)
	20	1/0.813	0.81	0.40	1.61	35.20	15	2,000	11.2	610(2,000)
	18	1/1.024	1.02	0.40	1.82	22.20	15	2,000	15.0	305(1,000)
	16	1/1.290	1.29	0.40	2.09	14.00	15	2,000	20.0	305(1,000)
TA-SC	26	7/0.160	0.48	0.40	1.28	150.00	15	2,000	4.8	610(2,000)
	24	7/0.203	0.61	0.40	1.41	94.20	15	2,000	6.4	610(2,000)
	22	7/0.254	0.76	0.40	1.56	59.40	15	2,000	8.5	610(2,000)

- Remarks 1) Size range : UL 30-10AWG, CSA 26-10AWG
2) Allowable current : Ambient temperature 40°C, Max. allowable temperature 105°C, single-wire in air

1-10 Lead Wire

Lead Free PVC insulated wire

UL Style No.1571

- Rating UL : 30V, 80°C
- Standard UL : UL Subject 758

Application

Internal wiring of small-scale electronic equipments such as mini cassettes, radio receivers and cameras.

Features

1. Flame retardant : UL VW-1, Material Control Law -F-
2. Small diameter saves space.
3. Wire for moving section as these wires are very soft.
4. Can be produced with or without cross-linking.
5. EU Directive RoHS : Restricted use of Pb, Cd, Hg, Cr+6, PBBs, PBDEs

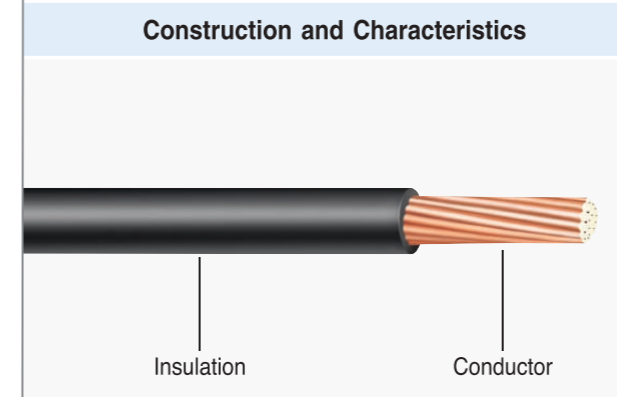

Marking

1571 E52853 VW-1 AWM AWG NO. LS Cable -F- LF

Type	Conductor			Insulation		Max. Cond. Resistance (20°C) (Ω/km)	Min. Insulation Resistance (15.6°C) (MΩ·km)	Dielectric Strength (AC) (V/1min)	Unit Length (m) (ft)
	Size (AWG)	Construction (No./mm)	Diameter (mm)	Nominal Thickness (mm)	Diameter (mm)				
Stranded	30	7/0.102	0.31	0.25	0.81	381.00	15	500	1,220(4,000)
	28	7/0.127	0.38	0.25	0.88	239.00	15	500	1,220(4,000)
	26	7/0.160	0.48	0.25	0.98	150.00	15	500	1,220(4,000)
	24	11/0.160	0.61	0.25	1.11	94.20	15	500	610(2,000)
	22	17/0.160	0.76	0.35	1.46	59.40	15	500	610(2,000)
	Solid	30	1/0.254	0.26	0.25	0.76	361.00	15	500
28		1/0.320	0.32	0.25	0.82	227.00	15	500	1,220(4,000)
26		1/0.404	0.40	0.25	0.90	143.00	15	500	1,220(4,000)
24		1/0.511	0.51	0.25	1.01	89.30	15	500	610(2,000)
TA-SC	22	1/0.643	0.64	0.35	1.34	56.40	15	500	610(2,000)
	28	7/0.127	0.38	0.25	0.88	239.00	15	2,000	1,220(4,000)
	26	7/0.160	0.48	0.25	0.98	150.00	15	2,000	1,220(4,000)
TA-SC	24	7/0.203	0.61	0.25	1.11	94.20	15	2,000	610(2,000)

- Remarks 1) Size range : Min. 50AWG
2) Marking size : Not less than 28AWG

1-11 Lead Wire

Lead Free Heat-resistant PVC double-insulated wire

UL Style No.1617 CSA Type TEW

- Rating UL : 600V, 105°C / CSA : 600V, 105°C
- Standard UL : UL Subject 758 / CSA : CSA C22.2 NO.127

Application

Internal wiring of audio/video equipments.

Features

1. Standard : For both UL and CSA
2. Flame retardant : UL VW-1, CSA FT1, Material Control Law -F-
3. The thickness of every layers is more than 0.4mm, and effective on the European Standard and the Electrical Appliances and Material Control Law.
4. EU Directive RoHS : Restricted use of Pb, Cd, Hg, Cr+6, PBBs, PBDEs

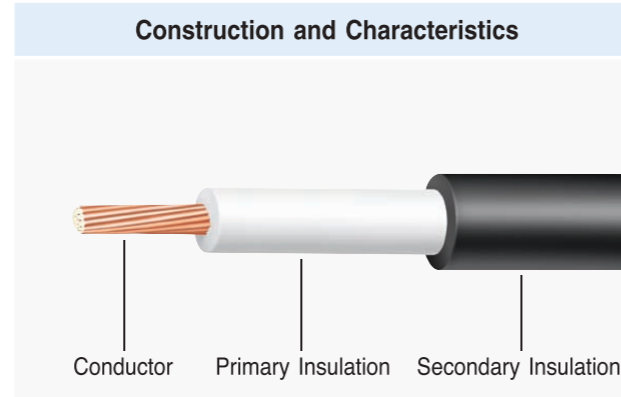

Marking

1617 E52853 VW-1 AWM 105C LL33911 CSA TEW 105C FT1 AWG NO. LS Cable -F- LF

Type	Conductor			Insulation		Sheath		Max. Cond. Resistance (20°C) (Ω/km)	Min. Insulation Resistance (15.6°C) (MΩ·km)	Dielectric Strength (AC) (V/1min)	Allowable Current (reference) (A)	Unit Length (m) (ft)
	Size (AWG)	Construction (No./mm)	Diameter (mm)	Nominal Thickness (mm)	Diameter (mm)	Nominal Thickness (mm)	Diameter (mm)					
Stranded	26	7/0.160	0.48	0.79	2.06	0.24	2.54	150.00	55	2,000	11.2	305(1,000)
	24	11/0.160	0.61	0.79	2.19	0.24	2.67	94.20	42	2,000	12.6	305(1,000)
	22	17/0.160	0.76	0.79	2.34	0.24	2.82	59.40	36	2,000	14.6	305(1,000)
	20	26/0.160	0.94	0.79	2.52	0.48	3.48	36.70	31	2,000	17.2	305(1,000)
	18	41/0.160	1.18	0.79	2.76	0.48	3.72	23.20	27	2,000	21.9	305(1,000)
	16	26/0.254	1.49	0.79	3.07	0.48	4.03	14.60	23	2,000	28.9	305(1,000)
	14	41/0.254	1.88	0.79	3.46	0.48	4.42	8.96	18	2,000	37.6	305(1,000)
Solid	26	1/0.404	0.40	0.79	1.98	0.24	2.46	143.00	55	2,000	10.6	305(1,000)
	24	1/0.511	0.51	0.79	2.09	0.24	2.57	89.30	42	2,000	11.8	305(1,000)
	22	1/0.643	0.64	0.79	2.22	0.48	3.18	56.40	40	2,000	13.6	305(1,000)
	20	1/0.813	0.81	0.79	2.39	0.48	3.35	35.20	34	2,000	16.3	305(1,000)
	18	1/1.024	1.02	0.79	2.60	0.48	3.56	22.20	30	2,000	20.3	305(1,000)
	16	1/1.290	1.29	0.79	2.87	0.48	3.83	14.00	26	2,000	26.0	305(1,000)
	14	1/1.630	1.63	0.79	3.21	0.48	4.17	8.78	22	2,000	34.7	305(1,000)
TA-SC	24	7/0.203	0.61	0.79	2.19	0.24	2.67	94.20	42	2,000	12.4	305(1,000)
	22	7/0.254	0.76	0.79	2.34	0.24	2.82	59.40	36	2,000	15.0	305(1,000)

- Remarks 1) Size range : UL 28-9AWG, CSA 26-10AWG
 2) Allowable current : Ambient temperature 40°C, Max. allowable temperature 105°C, single-wire in air
 3) Standard color of primary insulation : White

1-12 Lead Wire

Lead Free Heat-resistant PVC double-insulated wire

UL Style No.1618

- Rating UL : 300V, 80°C
- Standard UL : UL Subject 758

Application

Internal wiring of audio/video equipments.

Features

1. Flame retardant : UL VW-1, CSA FT1, Material Control Law -F-
2. The thickness of every layers is more than 0.4mm, and effective on the European Standard and the Electrical Appliances and Material Control Law.
3. EU Directive RoHS : Restricted use of Pb, Cd, Hg, Cr+6, PBBs, PBDEs

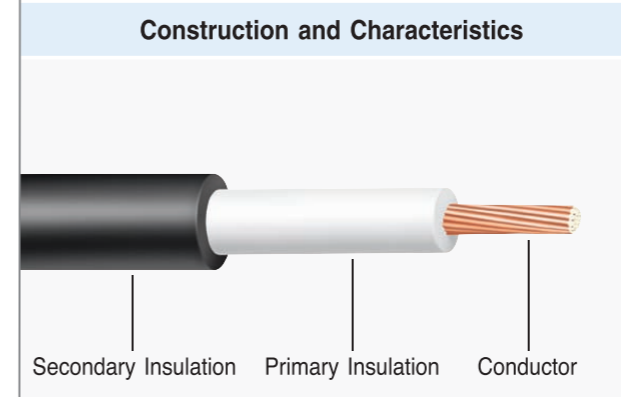

Marking

1618 E52853 VW-1 AWM AWG NO. LS Cable -F- LF

Type	Conductor			Insulation		Sheath		Max. Cond. Resistance (20°C) (Ω/km)	Min. Insulation Resistance (15.6°C) (MΩ·km)	Dielectric Strength (AC) (V/1min)	Allowable Current (reference) (A)	Unit Length (m) (ft)
	Size (AWG)	Construction (No./mm)	Diameter (mm)	Nominal Thickness (mm)	Diameter (mm)	Nominal Thickness (mm)	Diameter (mm)					
Stranded	26	7/0.160	0.48	0.40	1.28	0.51	2.30	150.00	15	2,000	7.3	305(1,000)
	24	11/0.160	0.61	0.40	1.41	0.51	2.43	94.20	15	2,000	8.6	305(1,000)
	22	17/0.160	0.76	0.40	1.56	0.51	2.58	59.40	15	2,000	10.2	305(1,000)
	20	26/0.160	0.94	0.40	1.74	0.51	2.76	36.70	15	2,000	12.7	305(1,000)
	18	41/0.160	1.18	0.40	1.98	0.51	3.00	23.20	15	2,000	16.9	305(1,000)
	16	26/0.254	1.49	0.40	2.29	0.51	3.31	14.60	15	2,000	22.9	305(1,000)
	Solid	26	1/0.404	0.40	0.40	1.20	0.51	2.22	143.00	15	2,000	6.8
24		1/0.511	0.51	0.40	1.31	0.51	2.33	89.30	15	2,000	8.0	305(1,000)
22		1/0.643	0.64	0.40	1.44	0.51	2.46	56.40	15	2,000	9.6	305(1,000)
20		1/0.813	0.81	0.40	1.61	0.51	2.63	35.20	15	2,000	12.0	305(1,000)
18		1/1.024	1.02	0.40	1.82	0.51	2.84	22.20	15	2,000	15.6	305(1,000)
16		1/1.290	1.29	0.40	2.09	0.51	3.11	14.00	15	2,000	21.0	305(1,000)
TA-SC	24	7/0.203	0.61	0.40	1.41	0.51	2.43	94.20	15	2,000	12.4	305(1,000)
	22	7/0.254	0.76	0.40	1.56	0.51	2.58	59.40	15	2,000	15.0	305(1,000)

- Remarks 1) Size range : UL 28-16AWG
 2) Allowable current : Ambient temperature 40°C, Max. allowable temperature 80°C, single-wire in air
 3) Standard color of primary insulation : White

2-1 Irradiated Wire

Lead Free Irradiated XLPVC insulated wire

UL Style No.1429 CSA Type AWM

- Rating UL : 150V, 80°C / CSA : 150V, 80°C
- Standard UL : UL Subject 758 / CSA : CSA C22.2 NO.210-2

Application

Internal wiring of electrical and electronic equipments which are mainly small.

Features

1. Standard : For both UL and CSA
2. Flame retardant : UL VW-1, CSA FT1, Material Control Law -F-
3. Thermally stable due to radiation cross-linking, thus insulation does not melt at 350°C (5 sec or less).
4. Small diameter saves space.
5. EU Directive RoHS : Restricted use of Pb, Cd, Hg, Cr+6, PBBs, PBDEs

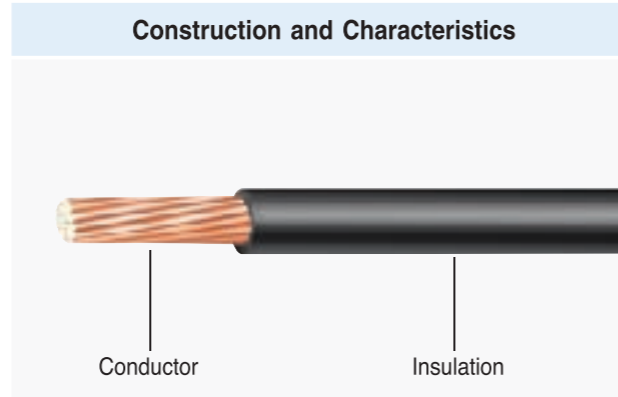

Marking

1429 E52853 VW-1 AWM LL57184 CSA AWM I A 80C 150V FT1 AWG NO. LS Cable -F- LF

Type	Conductor			Insulation		Max. Cond. Resistance (20°C) (Ω /km)	Min. Insulation Resistance (15.6°C) (M Ω ·km)	Dielectric Strength (AC) (V/1min)	Allowable Current (reference) (A)	Unit Length (m) (ft)
	Size (AWG)	Construction (No./mm)	Diameter (mm)	Nominal Thickness (mm)	Diameter (mm)					
Stranded	30	7/0.102	0.31	0.27	0.85	381.00	15	2,000	2.0	610(2,000)
	28	7/0.127	0.38	0.27	0.92	239.00	15	2,000	2.6	610(2,000)
	26	7/0.160	0.48	0.27	1.02	150.00	15	2,000	3.5	610(2,000)
	24	11/0.160	0.61	0.27	1.15	94.20	15	2,000	4.7	610(2,000)
	22	17/0.160	0.76	0.27	1.30	59.40	15	2,000	6.4	610(2,000)
	20	26/0.160	0.94	0.27	1.48	36.70	15	2,000	8.5	610(2,000)
	18	41/0.160	1.18	0.27	1.72	23.20	15	2,000	11.5	305(1,000)
	16	26/0.254	1.49	0.27	2.03	14.60	15	2,000	15.4	305(1,000)
	Solid	30	1/0.254	0.26	0.27	0.80	361.00	15	2,000	2.0
28		1/0.320	0.32	0.27	0.86	227.00	15	2,000	2.6	610(2,000)
26		1/0.404	0.40	0.27	0.94	143.00	15	2,000	3.5	610(2,000)
24		1/0.511	0.51	0.27	1.05	89.30	15	2,000	4.7	610(2,000)
22		1/0.643	0.64	0.27	1.18	56.40	15	2,000	6.4	610(2,000)
20		1/0.813	0.81	0.27	1.35	35.20	15	2,000	8.5	610(2,000)
18		1/1.024	1.02	0.27	1.56	22.20	15	2,000	11.5	305(1,000)
16		1/1.290	1.29	0.27	1.83	14.00	15	2,000	15.4	305(1,000)
TA-SC		26	7/0.160	0.48	0.27	1.02	150.00	15	2,000	3.5
	24	7/0.203	0.61	0.27	1.15	94.20	15	2,000	4.7	610(2,000)
	22	7/0.254	0.76	0.27	1.30	59.40	15	2,000	6.4	610(2,000)

- Remarks 1) Size range : UL 32-16AWG
2) Allowable current : Ambient temperature 40°C, Max. allowable temperature 80°C, single-wire in air

2-2 Irradiated Wire

Lead Free Irradiated XLPVC insulated wire

UL Style No.1430 CSA Type REW(XLPVC)

- Rating UL : 300V, 105°C / CSA : 300V, 105°C
- Standard UL : UL Subject 758 / CSA : CSA C22.2 NO.127

Application

Internal wiring of electrical and electronic equipments which are mainly small (Wiring inside high temperature units such as dryers, hair curlers, rice warmers and toasters. Transformer lead wires, wiring of light fixtures).

Features

1. Standard : For both UL and CSA
2. Flame retardant : UL VW-1, CSA FT1, Material Control Law -F-
3. Thermally stable due to radiation cross-linking, thus insulation does not melt at 350°C (5 sec or less).
4. Excellent mechanical strength, oil-resistance, chemical-resistance.
5. EU Directive RoHS : Restricted use of Pb, Cd, Hg, Cr+6, PBBs, PBDEs

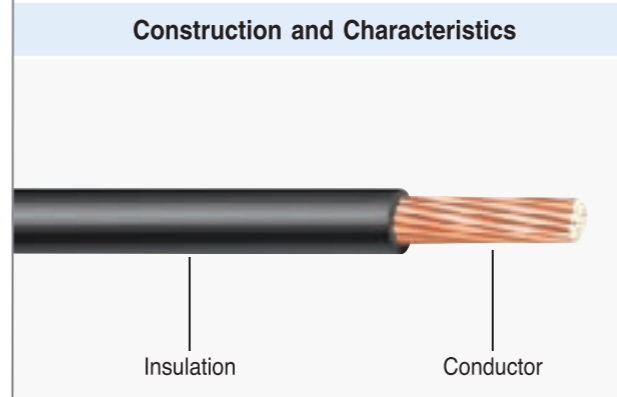

Marking

1430 E52853 VW-1 AWM 105C LL33911 CSA REW(XLPVC) FT1 105C 300V AWG NO. LS Cable -F- LF

Type	Conductor			Insulation		Max. Cond. Resistance (20°C) (Ω /km)	Min. Insulation Resistance (15.6°C) (M Ω ·km)	Dielectric Strength (AC) (V/1min)	Allowable Current (reference) (A)	Unit Length (m) (ft)
	Size (AWG)	Construction (No./mm)	Diameter (mm)	Nominal Thickness (mm)	Diameter (mm)					
Stranded	30	7/0.102	0.31	0.42	1.15	381.00	15	2,000	2.7	610(2,000)
	28	7/0.127	0.38	0.42	1.22	239.00	15	2,000	3.6	610(2,000)
	26	7/0.160	0.48	0.42	1.32	150.00	15	2,000	4.8	610(2,000)
	24	11/0.160	0.61	0.42	1.45	94.20	15	2,000	6.4	610(2,000)
	22	17/0.160	0.76	0.42	1.60	59.40	15	2,000	8.5	610(2,000)
	20	26/0.160	0.94	0.42	1.78	36.70	15	2,000	11.2	610(2,000)
	18	41/0.160	1.18	0.42	2.02	23.20	15	2,000	15.0	305(1,000)
	16	26/0.254	1.49	0.42	2.33	14.60	15	2,000	20.0	305(1,000)
	Solid	30	1/0.254	0.26	0.42	1.10	361.00	15	2,000	2.7
28		1/0.320	0.32	0.42	1.16	227.00	15	2,000	3.6	610(2,000)
26		1/0.404	0.40	0.42	1.24	143.00	15	2,000	4.8	610(2,000)
24		1/0.511	0.51	0.42	1.35	89.30	15	2,000	6.4	610(2,000)
22		1/0.643	0.64	0.42	1.48	56.40	15	2,000	8.5	610(2,000)
20		1/0.813	0.81	0.42	1.65	35.20	15	2,000	11.2	610(2,000)
18		1/1.024	1.02	0.42	1.86	22.20	15	2,000	15.0	305(1,000)
16		1/1.290	1.29	0.42	2.13	14.00	15	2,000	20.0	305(1,000)
TA-SC		26	7/0.160	0.48	0.42	1.32	150.00	15	2,000	4.8
	24	7/0.203	0.61	0.42	1.45	94.20	15	2,000	6.4	610(2,000)
	22	7/0.254	0.76	0.42	1.60	59.40	15	2,000	8.5	610(2,000)

- Remarks 1) Size range : UL 30-16AWG, CSA 26-16AWG
2) Allowable current : Ambient temperature 40°C, Max. allowable temperature 105°C, single-wire in air

2-3 Irradiated Wire

Lead Free Irradiated XLPVC insulated wire

UL Style No.1431 CSA Type REW(XLPVC)

- Rating UL : 600V, 105°C / CSA : 600V, 105°C
- Standard UL : UL Subject 758 / CSA : CSA C22.2 NO.127

Application

Internal wiring of electrical and electronic equipments which are mainly small (Wiring inside high temperature units such as dryers, hair curlers, rice warmers and toasters).

Features

1. Standard : For both UL and CSA
2. Flame retardant : UL VW-1, CSA FT1, Material Control Law -F-
3. Thermally stable due to radiation cross-linking, thus insulation does not melt at 350°C (5 sec or less).
4. Excellent mechanical strength, oil-resistance, chemical-resistance.
5. EU Directive RoHS : Restricted use of Pb, Cd, Hg, Cr+6, PBBs, PBDEs

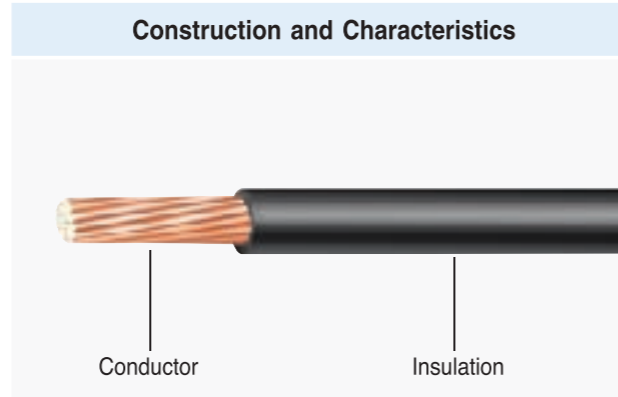

Marking

1431 E52853 VW-1  AWM 105C LL33911 CSA REW(XLPVC) FT1 105C 600V AWG NO. LS Cable -F- LF

Type	Conductor			Insulation		Max. Cond. Resistance (20°C) (Ω/km)	Min. Insulation Resistance (15.6°C) (MΩ·km)	Dielectric Strength (AC) (V/1min)	Allowable Current (reference) (A)	Unit Length (m) (ft)
	Size (AWG)	Construction (No./mm)	Diameter (mm)	Nominal Thickness (mm)	Diameter (mm)					
Stranded	30	7/0.102	0.31	0.81	1.93	381.00	15	2,000	3.4	610(2,000)
	28	7/0.127	0.38	0.81	2.00	239.00	15	2,000	4.4	610(2,000)
	26	7/0.160	0.48	0.81	2.10	150.00	15	2,000	5.8	610(2,000)
	24	11/0.160	0.61	0.81	2.23	94.20	15	2,000	7.6	610(2,000)
	22	17/0.160	0.76	0.81	2.38	59.40	15	2,000	10.0	610(2,000)
	20	26/0.160	0.94	0.81	2.56	36.70	15	2,000	13.1	610(2,000)
	18	41/0.160	1.18	0.81	2.80	23.20	15	2,000	17.2	305(1,000)
	16	26/0.254	1.49	0.81	3.11	14.60	15	2,000	22.3	305(1,000)
	14	41/0.254	1.88	0.81	3.50	36.70	15	2,000	29.6	305(1,000)
	12	65/0.254	2.36	0.81	3.98	23.20	15	2,000	38.8	305(1,000)
	10	66/0.320	3.00	0.81	4.62	14.60	15	2,000	52.4	305(1,000)
	Solid	30	1/0.254	0.26	0.81	1.88	361.00	15	2,000	3.4
28		1/0.320	0.32	0.81	1.94	227.00	15	2,000	4.4	610(2,000)
26		1/0.404	0.40	0.81	2.02	143.00	15	2,000	5.8	610(2,000)
24		1/0.511	0.51	0.81	2.13	89.30	15	2,000	7.6	610(2,000)
22		1/0.643	0.64	0.81	2.26	56.40	15	2,000	10.0	610(2,000)
20		1/0.813	0.81	0.81	2.43	35.20	15	2,000	13.1	610(2,000)
TA-SC	26	7/0.160	0.48	0.81	2.10	150.00	15	2,000	5.8	610(2,000)
	24	7/0.203	0.61	0.81	2.23	94.20	15	2,000	7.6	610(2,000)
	22	7/0.254	0.76	0.81	2.38	59.40	15	2,000	10.0	610(2,000)

- Remarks 1) Size range : UL 30-1KMCM, CSA 24-4AWG
2) Allowable current : Ambient temperature 40°C, Max. allowable temperature 105°C, single-wire in air

2-4 Irradiated Wire

Lead Free Irradiated XLPVC insulated wire

UL Style No. 3443

- Rating UL : 300V, 105°C
- Standard UL : UL Subject 758

Application

Internal wiring of small-scale electronic equipment such as notebook computer, CDP, DVD, and mini cassettes.

Features

1. Flame retardant : UL VW-1, Material Control Law -F-
2. Small diameter saves space.
3. Suitable for moving parts due to excellent flexibility.
4. EU Directive RoHS : Restricted use of Pb, Cd, Hg, Cr+6, PBBs, PBDEs

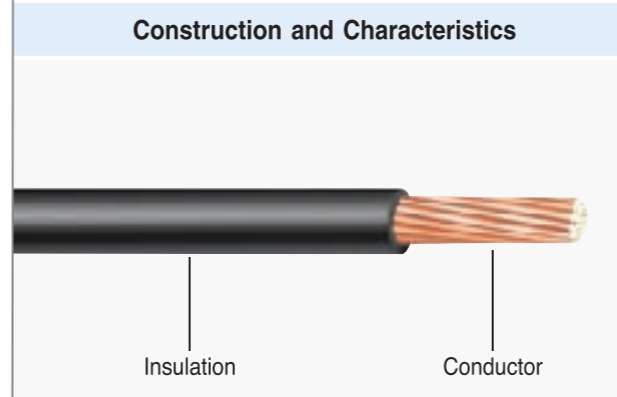

Marking

3443 E52853 VW-1  AWM 150C 300V AWG NO. LS Cable -F-

Type	Conductor			Insulation		Max. Cond. Resistance (20°C) (Ω/km)	Min. Insulation Resistance (15.6°C) (MΩ·km)	Dielectric Strength (AC) (V/1min)	Unit Length (m) (ft)
	Size (AWG)	Construction (No./mm)	Diameter (mm)	Nominal Thickness (mm)	Diameter (mm)				
Stranded	30	7/0.102	0.31	0.27	0.85	381.00	10	2,000	1,220(4,000)
	28	7/0.127	0.38	0.27	0.92	239.00	10	2,000	1,220(4,000)
	26	19/0.102	0.51	0.27	1.05	150.00	10	2,000	610(2,000)
	26	7/0.160	0.48	0.27	1.02	150.00	10	2,000	610(2,000)
	24	19/0.127	0.64	0.27	1.18	94.20	10	2,000	610(2,000)
	24	11/0.160	0.61	0.27	1.15	94.20	10	2,000	610(2,000)
	24	7/0.203	0.61	0.27	1.15	94.20	10	2,000	610(2,000)
	Solid	30	1/0.254	0.26	0.27	0.80	361.00	10	2,000
28		1/0.320	0.32	0.27	0.86	227.00	10	2,000	1,220(4,000)
26		1/0.404	0.40	0.27	0.94	143.00	10	2,000	1,220(4,000)
24		1/0.511	0.51	0.27	1.05	89.30	10	2,000	610(2,000)

- Remarks 1) Size range : UL 30-10AWG

2-5 Irradiated Wire

Lead Free Irradiated XLPVC double-insulated wire

UL Style No.1672 CSA Type AWM

- Rating UL : 300V, 105°C / CSA : 300V, 105°C
- Standard UL : UL Subject 758 / CSA : CSA C22.2 NO.210-2

Application

Internal wiring of audio/video equipments.

Features

1. Standard : For both UL and CSA
2. Flame retardant : UL VW-1, CSA FT1, Material Control Law -F-
3. The minimum thickness of every layers is more than 0.4mm, and effective on the European Standard and the Electrical Appliances and Material Control Law.
4. Excellent abrasion resistance and mechanical strength due to radiation cross-linking.
5. EU Directive RoHS : Restricted use of Pb, Cd, Hg, Cr+6, PBBs, PBDEs

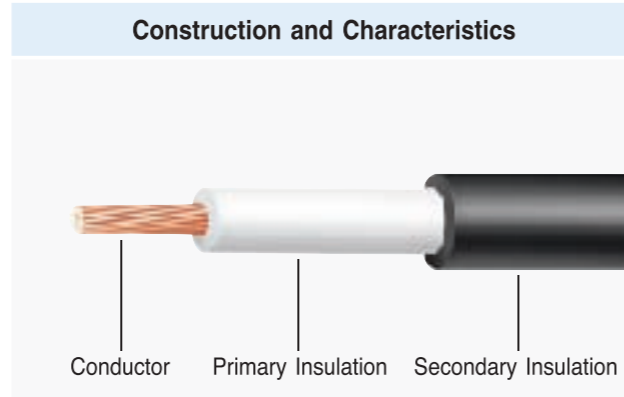

Marking

1672 E52853 VW-1 AWM 105C LL57184 CSA AWM I A 105C 300V FT1 AWG NO. LS Cable -F- LF

Type	Conductor			Primary		Secondary Insulation		Max. Cond. Resistance (20°C) (Ω/km)	Min. Insulation Resistance (15.6°C) (MΩ·km)	Dielectric Strength (AC) (V/1min)	Unit Length (m) (ft)
	Size (AWG)	Construction (No./mm)	Diameter (mm)	Nominal Thickness (mm)	Diameter (mm)	Nominal Thickness (mm)	Diameter (mm)				
Stranded	26	7/0.160	0.48	0.50	1.48	0.50	2.48	150.00	15	4,000	305(1,000)
	24	11/0.160	0.61	0.50	1.61	0.50	2.61	94.20	15	4,000	305(1,000)
	22	17/0.160	0.76	0.50	1.76	0.50	2.76	59.40	15	4,000	305(1,000)
	20	26/0.160	0.94	0.50	1.94	0.50	2.94	36.70	15	4,000	305(1,000)
	18	41/0.160	1.18	0.50	2.18	0.50	3.18	23.20	15	4,000	305(1,000)
	16	26/0.254	1.49	0.50	2.49	0.50	3.49	14.60	15	4,000	305(1,000)
Solid	26	1/0.404	0.40	0.50	1.40	0.50	2.40	143.00	15	4,000	305(1,000)
	24	1/0.511	0.51	0.50	1.51	0.50	2.51	89.30	15	4,000	305(1,000)
	22	1/0.643	0.64	0.50	1.64	0.50	2.64	56.40	15	4,000	305(1,000)
	20	1/0.813	0.81	0.50	1.81	0.50	2.81	35.20	15	4,000	305(1,000)
	18	1/1.024	1.02	0.50	2.02	0.50	3.02	22.20	15	4,000	305(1,000)
	16	1/1.290	1.29	0.50	2.29	0.50	3.29	14.00	15	4,000	305(1,000)
TA-SC	24	7/0.203	0.61	0.50	1.61	0.50	2.61	94.20	15	4,000	305(1,000)
	22	7/0.254	0.76	0.50	1.76	0.50	2.76	59.40	15	4,000	305(1,000)
	20	7/0.320	0.96	0.50	1.96	0.50	2.96	36.70	15	4,000	305(1,000)

- Remarks 1) Size range : UL 30-16AWG, CSA 26-10AWG
 2) Allowable current : Ambient temperature 40°C, Max. allowable temperature 105°C, single-wire in air
 3) Standard color of the primary insulation : White

2-6 Irradiated Wire

Lead Free Irradiated XLPVC double-insulated wire

UL Style No.1673

- Rating UL : 600V, 105°C
- Standard UL : UL Subject 758

Application

Internal wiring of electronic equipments such as a video.

Features

1. Flame retardant : UL VW-1, Material Control Law -F-
2. The minimum thickness of every layers is more than 0.4mm, and effective on the European Standard and the Electrical Appliances and Material Control Law.
3. Excellent abrasion resistance and mechanical strength due to radiation cross-linking.
4. EU Directive RoHS : Restricted use of Pb, Cd, Hg, Cr+6, PBBs, PBDEs

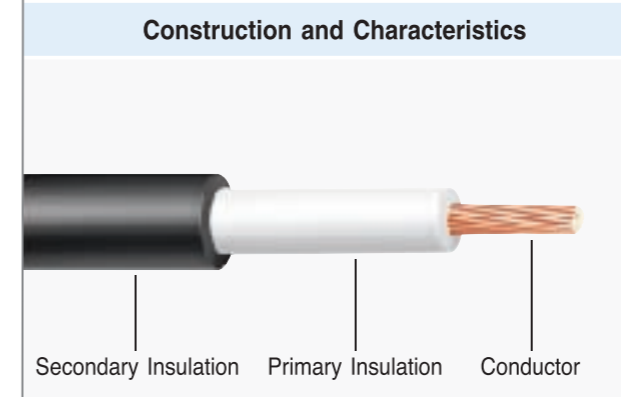

Marking

1673 E52853 VW-1 AWM 105C 600V AWG NO. LS Cable -F- LF

Type	Conductor			Primary		Secondary Insulation		Max. Cond. Resistance (20°C) (Ω/km)	Min. Insulation Resistance (15.6°C) (MΩ·km)	Dielectric Strength (AC) (V/1min)	Unit Length (m) (ft)
	Size (AWG)	Construction (No./mm)	Diameter (mm)	Nominal Thickness (mm)	Diameter (mm)	Nominal Thickness (mm)	Diameter (mm)				
Stranded	22	17/0.160	0.76	0.81	2.38	0.50	3.38	59.40	15	2,000	305(1,000)
	20	26/0.160	0.94	0.81	2.56	0.50	3.56	36.70	15	2,000	305(1,000)
	18	41/0.160	1.18	0.81	2.80	0.50	3.80	23.20	15	2,000	305(1,000)
	16	26/0.254	1.49	0.81	3.11	0.50	4.11	14.60	15	2,000	305(1,000)
	14	41/0.254	1.88	0.81	3.50	0.50	4.50	8.96	15	2,000	305(1,000)
	12	65/0.254	2.36	0.81	3.98	0.50	4.98	5.64	15	2,000	305(1,000)
	10	66/0.320	3.00	0.81	4.62	0.50	5.62	3.55	15	2,000	305(1,000)
	Solid	22	1/0.643	0.64	0.81	2.26	0.50	3.26	56.40	15	2,000
20		1/0.813	0.81	0.81	2.43	0.50	3.43	35.20	15	2,000	305(1,000)
18		1/1.024	1.02	0.81	2.64	0.50	3.64	22.20	15	2,000	305(1,000)
16		1/1.290	1.29	0.81	2.91	0.50	3.91	14.00	15	2,000	305(1,000)
14		1/1.630	1.63	0.81	3.25	0.50	4.25	8.78	15	2,000	305(1,000)
12		1/2.050	2.05	0.81	3.67	0.50	4.67	5.53	15	2,000	305(1,000)
TA-SC	24	7/0.203	0.61	0.81	2.23	0.50	3.23	94.20	15	2,000	305(1,000)
	22	7/0.254	0.76	0.81	2.38	0.50	3.38	59.40	15	2,000	305(1,000)

- Remarks 1) Size range : UL 30-4/0AWG
 2) Allowable current : Ambient temperature 40°C, Max. allowable temperature 105°C, single-wire in air
 3) Standard color of the primary insulation : White

2-7 Irradiated Wire

Lead Free Heat-resistant irradiated XLPE insulated wire

UL Style No.3265

- Rating UL : 150V, 125°C
- Standard UL : UL Subject 758

Application

1. Internal wiring of electrical and electronic equipments.
2. Internal wiring of hair dryers and small electric heaters.

Features

1. Flame retardant : UL VW-1, Material Control Law -F-
2. Thermally stable due to radiation cross-linking, thus insulation does not melt at 350°C (5 sec or less).
3. Small diameter saves space.
4. EU Directive RoHS : Restricted use of Pb, Cd, Hg, Cr+6, PBBs, PBDEs

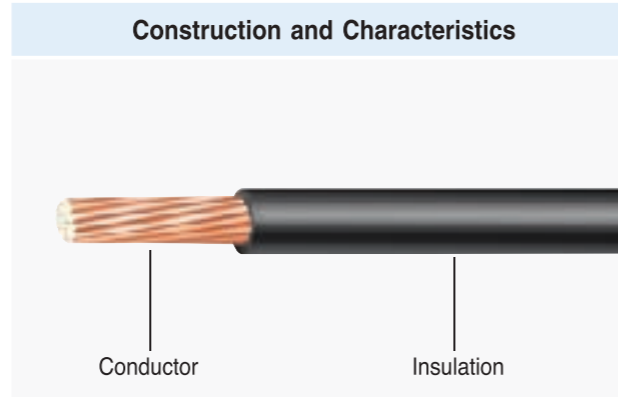

Marking

3265 E52853 VW-1 AWM 125C 150V AWG NO. LS Cable -F- LF

Type	Conductor			Insulation		Max. Cond. Resistance (20°C) (Ω/km)	Min. Insulation Resistance (15.6°C) (MΩ·km)	Dielectric Strength (AC) (V/1min)	Allowable Current (reference) (A)	Unit Length (m) (ft)
	Size (AWG)	Construction (No./mm)	Diameter (mm)	Nominal Thickness (mm)	Diameter (mm)					
Stranded	30	7/0.102	0.31	0.28	0.87	381.00	50	2,000	2.3	1,220(4,000)
	28	7/0.127	0.38	0.28	0.94	239.00	50	2,000	2.9	1,220(4,000)
	26	7/0.160	0.48	0.28	1.04	150.00	50	2,000	4.0	610(2,000)
	24	11/0.160	0.61	0.28	1.17	94.20	50	2,000	5.3	610(2,000)
	22	17/0.160	0.76	0.28	1.32	59.40	50	2,000	7.3	610(2,000)
	20	26/0.160	0.94	0.28	1.50	36.70	50	2,000	9.7	610(2,000)
	18	41/0.160	1.18	0.28	1.74	23.20	50	2,000	13.1	610(2,000)
	16	26/0.254	1.49	0.28	2.05	14.60	50	2,000	17.6	305(1,000)
Solid	30	1/0.254	0.26	0.28	0.82	361.00	50	2,000	2.3	1,220(4,000)
	28	1/0.320	0.32	0.28	0.88	227.00	50	2,000	2.9	1,220(4,000)
	26	1/0.404	0.40	0.28	0.96	143.00	50	2,000	4.0	610(2,000)
	24	1/0.511	0.51	0.28	1.07	89.30	50	2,000	5.3	610(2,000)
	22	1/0.643	0.64	0.28	1.20	56.40	50	2,000	7.3	610(2,000)
	20	1/0.813	0.81	0.28	1.37	35.20	50	2,000	9.7	610(2,000)
	18	1/1.024	1.02	0.28	1.58	22.20	50	2,000	13.1	610(2,000)
	16	1/1.290	1.29	0.28	1.85	14.00	50	2,000	17.6	305(1,000)
TA-SC	26	7/0.160	0.48	0.28	1.04	150.00	50	2,000	4.0	610(2,000)
	24	7/0.203	0.61	0.28	1.17	94.20	50	2,000	5.3	610(2,000)
	22	7/0.254	0.76	0.28	1.32	59.40	50	2,000	7.3	610(2,000)

- Remarks 1) Size range : UL 32-16AWG
2) Allowable current : Ambient temperature 40°C, Max. allowable temperature 125°C, single-wire in air

2-8 Irradiated Wire

Lead Free Heat-resistant irradiated XLPE insulated wire

UL Style No.3266 CSA Type CL1252/AWM

- Rating UL : 300V, 125°C / CSA : 300V, 125°C
- Standard UL : UL Subject 758 / CSA : CSA C22.2 NO.210-2

Application

1. Internal wiring of electrical and electronic equipments.
2. Internal wiring of hair dryers and small electric heaters.

Features

1. Standard : For both UL and CSA
2. Flame retardant : UL VW-1, Material Control Law -F-
3. Thermally stable due to radiation cross-linking, thus insulation does not melt at 350°C (5 sec or less).
4. EU Directive RoHS : Restricted use of Pb, Cd, Hg, Cr+6, PBBs, PBDEs

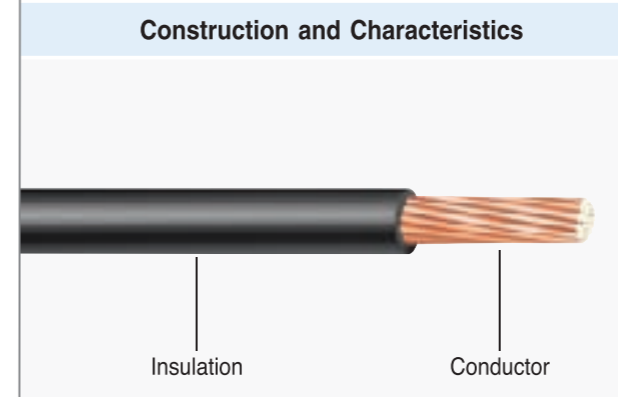

Marking

3266 E52853 VW-1 AWM 125C LL57183 CSA CL1252 XLPE 125C 300V FT1 AWG NO. LS Cable -F- LF

Type	Conductor			Insulation		Max. Cond. Resistance (20°C) (Ω/km)	Min. Insulation Resistance (15.6°C) (MΩ·km)	Dielectric Strength (AC) (V/1min)	Allowable Current (reference) (A)	Unit Length (m) (ft)
	Size (AWG)	Construction (No./mm)	Diameter (mm)	Nominal Thickness (mm)	Diameter (mm)					
Stranded	28	7/0.127	0.38	0.42	1.22	239.00	50	2,000	4.1	610(2,000)
	26	7/0.160	0.48	0.42	1.32	150.00	50	2,000	5.5	610(2,000)
	24	11/0.160	0.61	0.42	1.45	94.20	50	2,000	7.3	610(2,000)
	22	17/0.160	0.76	0.42	1.60	59.40	50	2,000	9.7	610(2,000)
	20	26/0.160	0.94	0.42	1.78	36.70	50	2,000	12.8	610(2,000)
	18	41/0.160	1.18	0.42	2.02	23.20	50	2,000	17.1	305(1,000)
	16	26/0.254	1.49	0.42	2.33	14.60	50	2,000	22.8	305(1,000)
	14	41/0.254	1.88	0.42	2.72	8.96	50	2,000	30.3	305(1,000)
Solid	28	1/0.320	0.32	0.42	1.16	227.00	50	2,000	4.1	610(2,000)
	26	1/0.404	0.40	0.42	1.24	143.00	50	2,000	5.5	610(2,000)
	24	1/0.511	0.51	0.42	1.35	89.30	50	2,000	7.3	610(2,000)
	22	1/0.643	0.64	0.42	1.48	56.40	50	2,000	9.7	610(2,000)
	20	1/0.813	0.81	0.42	1.65	35.20	50	2,000	12.8	610(2,000)
	18	1/1.024	1.02	0.42	1.86	22.20	50	2,000	17.1	305(1,000)
	16	1/1.290	1.29	0.42	2.13	14.00	50	2,000	22.8	305(1,000)
	14	1/1.630	1.63	0.42	2.47	8.78	50	2,000	30.3	305(1,000)
TA-SC	28	7/0.127	0.38	0.42	1.22	239.00	50	2,000	4.1	610(2,000)
	26	7/0.160	0.48	0.42	1.32	150.00	50	2,000	5.5	610(2,000)
	24	7/0.203	0.61	0.42	1.45	94.20	50	2,000	7.3	610(2,000)
	22	7/0.254	0.76	0.42	1.60	59.40	50	2,000	9.7	610(2,000)
	20	7/0.320	0.96	0.42	1.80	36.70	50	2,000	12.8	610(2,000)
	18	7/0.404	1.21	0.42	2.05	23.20	50	2,000	17.1	305(1,000)

- Remarks 1) Size range : UL 32-10AWG, CSA CL1252 22-16AWG, AWM 32-10AWG
2) Allowable current : Ambient temperature 40°C, Max. allowable temperature 125°C, single-wire in air

2-9 Irradiated Wire

Lead Free Heat-resistant irradiated XLPE insulated wire

UL Style No.3173 CSA Type CL1251

- Rating UL : 600V, 125°C / CSA : 600V, 125°C
- Standard UL : UL Subject 758 / CSA : CSA C22.2 NO.127

Application

1. Internal wiring of electrical and electronic equipments.
2. Lead wires of motors.

Features

1. Standard : For both UL and CSA
2. Flame retardant : UL VW-1, CSA FT1, Material Control Law -F-
3. Thermally stable due to radiation cross-linking, thus insulation does not melt at 350°C (5 sec or less).
4. EU Directive RoHS : Restricted use of Pb, Cd, Hg, Cr+6, PBBs, PBDEs

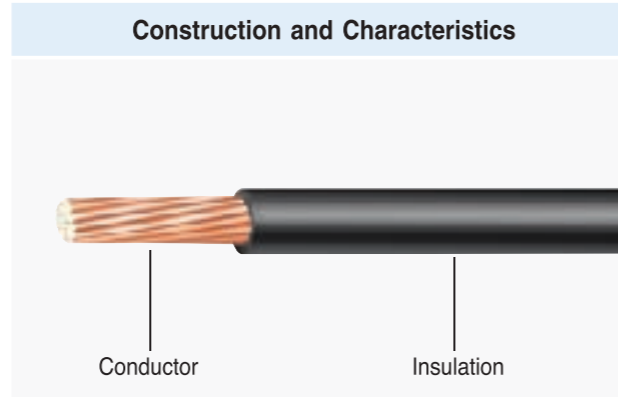

Marking

3173 E52853 VW-1 AWM 125C 600V LL57183 CSA CL1251 XLPE 125C 600V FT1 AWG NO. LS Cable -F- LF

Type	Conductor			Insulation		Max. Cond. Resistance (20°C) (Ω/km)	Min. Insulation Resistance (15.6°C) (MΩ·km)	Dielectric Strength (AC) (V/1min)	Allowable Current (reference) (A)	Unit Length (m) (ft)
	Size (AWG)	Construction (No./mm)	Diameter (mm)	Nominal Thickness (mm)	Diameter (mm)					
Stranded	22	17/0.160	0.76	0.81	2.38	59.40	50	2,000	13.5	305(1,000)
	20	26/0.160	0.94	0.81	2.56	36.70	50	2,000	17.6	305(1,000)
	18	41/0.160	1.18	0.81	2.80	23.20	50	2,000	23.2	305(1,000)
	16	26/0.254	1.49	0.81	3.11	14.60	50	2,000	30.7	305(1,000)
	14	41/0.254	1.88	0.81	3.50	8.96	50	2,000	41.0	305(1,000)
	12	65/0.254	2.36	0.81	3.98	5.64	50	2,000	54.8	305(1,000)
	10	66/0.320	3.00	0.81	4.62	3.55	50	2,000	74.6	305(1,000)
Solid	22	1/0.643	0.64	0.81	2.26	56.40	50	2,000	13.5	305(1,000)
	20	1/0.813	0.81	0.81	2.43	35.20	50	2,000	17.6	305(1,000)
	18	1/1.024	1.02	0.81	2.64	22.20	50	2,000	23.2	305(1,000)
	16	1/1.290	1.29	0.81	2.91	14.00	50	2,000	30.7	305(1,000)
	14	1/1.630	1.63	0.81	3.25	8.78	50	2,000	41.0	305(1,000)
	12	1/2.050	2.05	0.81	3.67	5.53	50	2,000	54.8	305(1,000)
	10	1/2.590	2.59	0.81	4.21	3.48	50	2,000	74.6	305(1,000)

- Remarks 1) Size range : UL 26-9AWG, CSA 22-4/0AWG
2) Allowable current : Ambient temperature 40°C, Max. allowable temperature 125°C, single-wire in air

2-10 Irradiated Wire

Lead Free Heat-resistant irradiated XLPE insulated wire

UL Style No.3271 CSA Type CL1251

- Rating UL : 600V, 125°C / CSA : 600V, 125°C
- Standard UL : UL Subject 758 / CSA : CSA C22.2 NO.127/210.2

Application

1. Internal wiring of electrical and electronic equipments.
2. Lead wires of motors.

Features

1. Standard : For both UL and CSA
2. Flame retardant : UL VW-1, CSA FT1, Material Control Law -F-
3. Thermally stable due to radiation cross-linking, thus insulation does not melt at 350°C (5 sec or less).
4. EU Directive RoHS : Restricted use of Pb, Cd, Hg, Cr+6, PBBs, PBDEs

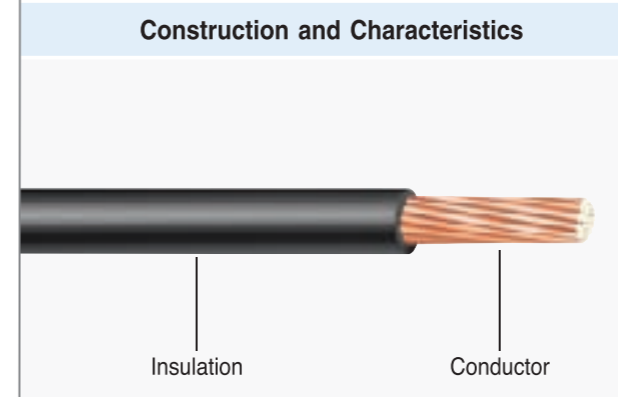

Marking

3271 E52853 VW-1 AWM 125C LL57183 CSA CL1251 XLPE 125C 600V FT1 AWG NO. LS Cable -F- LF

Type	Conductor			Insulation		Max. Cond. Resistance (20°C) (Ω/km)	Min. Insulation Resistance (15.6°C) (MΩ·km)	Dielectric Strength (AC) (V/1min)	Allowable Current (reference) (A)	Unit Length (m) (ft)
	Size (AWG)	Construction (No./mm)	Diameter (mm)	Nominal Thickness (mm)	Diameter (mm)					
Stranded	22	17/0.160	0.76	0.81	2.38	59.40	50	2,000	13.5	305(1,000)
	20	26/0.160	0.94	0.81	2.56	36.70	50	2,000	17.6	305(1,000)
	18	41/0.160	1.18	0.81	2.80	23.20	50	2,000	23.2	305(1,000)
	16	26/0.254	1.49	0.81	3.11	14.60	50	2,000	30.7	305(1,000)
	14	41/0.254	1.88	0.81	3.50	8.96	50	2,000	41.0	305(1,000)
	12	65/0.254	2.36	0.81	3.98	5.64	50	2,000	54.8	305(1,000)
	10	66/0.320	3.00	0.81	4.62	3.55	50	2,000	74.6	305(1,000)
Solid	22	1/0.643	0.64	0.81	2.26	56.40	50	2,000	13.5	305(1,000)
	20	1/0.813	0.81	0.81	2.43	35.20	50	2,000	17.6	305(1,000)
	18	1/1.024	1.02	0.81	2.64	22.20	50	2,000	23.2	305(1,000)
	16	1/1.290	1.29	0.81	2.91	14.00	50	2,000	30.7	305(1,000)
	14	1/1.630	1.63	0.81	3.25	8.78	50	2,000	41.0	305(1,000)
	12	1/2.050	2.05	0.81	3.67	5.53	50	2,000	54.8	305(1,000)
	10	1/2.590	2.59	0.81	4.21	3.48	50	2,000	74.6	305(1,000)

- Remarks 1) Size range : UL 30-4/0AWG, CSA 22-4/0AWG
2) Allowable current : Ambient temperature 40°C, Max. allowable temperature 125°C, single-wire in air

2-11 Irradiated Wire

Lead Free Heat-resistant irradiated XLPE insulated wire

UL Style No.3321 CSA Type AWM

- Rating UL : 600V, 150°C / CSA : 600V, 150°C
- Standard UL : UL Subject 758 / CSA : CSA C22.2 NO.210-2

Application

1. Internal wiring of electrical and electronic equipments.
2. Lead wires of motors.

Features

1. Standard : For both UL and CSA
2. Flame retardant : UL VW-1, CSA FT1, Material Control Law -F-
3. Thermally stable due to radiation cross-linking, thus insulation does not melt at 350°C (5 sec or less).
4. EU Directive RoHS : Restricted use of Pb, Cd, Hg, Cr+6, PBBs, PBDEs

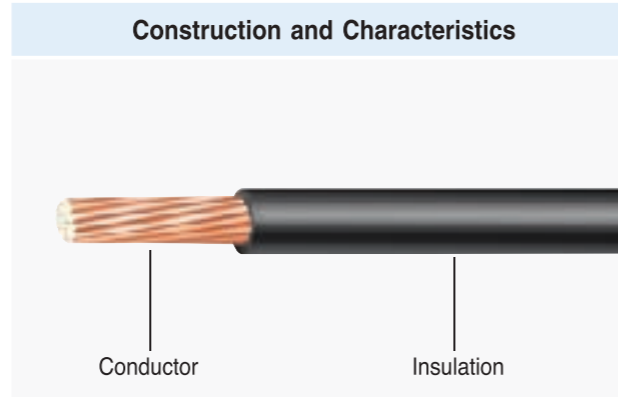

Marking

3321 E52853 VW-1 AWM 150C 600V LL57184 CSA AWM I A/B 150C 600V FT1 AWG NO. LS Cable -F- LF

Type	Conductor			Insulation		Max. Cond. Resistance (20°C) (Ω/km)	Min. Insulation Resistance (15.6°C) (MΩ·km)	Dielectric Strength (AC) (V/1min)	Allowable Current (reference) (A)	Unit Length (m) (ft)
	Size (AWG)	Construction (No./mm)	Diameter (mm)	Nominal Thickness (mm)	Diameter (mm)					
Stranded	22	17/0.160	0.76	0.81	2.38	59.40	1,000	1,500	13.5	305(1,000)
	20	26/0.160	0.94	0.81	2.56	36.70	1,000	1,500	17.6	305(1,000)
	18	41/0.160	1.18	0.81	2.80	23.20	1,000	1,500	23.2	305(1,000)
	16	26/0.254	1.49	0.81	3.11	14.60	1,000	1,500	30.7	305(1,000)
	14	41/0.254	1.88	0.81	3.50	8.96	1,000	1,500	41.0	305(1,000)
	12	65/0.254	2.36	0.81	3.98	5.64	1,000	1,500	54.8	305(1,000)
	10	66/0.320	3.00	0.81	4.62	3.55	1,000	1,500	74.6	305(1,000)
	Solid	22	1/0.643	0.64	0.81	2.26	56.40	1,000	1,500	13.5
20		1/0.813	0.81	0.81	2.43	35.20	1,000	1,500	17.6	305(1,000)
18		1/1.024	1.02	0.81	2.64	22.20	1,000	1,500	23.2	305(1,000)
16		1/1.290	1.29	0.81	2.91	14.00	1,000	1,500	30.7	305(1,000)
14		1/1.630	1.63	0.81	3.25	8.78	1,000	1,500	41.0	305(1,000)
12		1/2.050	2.05	0.81	3.67	5.53	1,000	1,500	54.8	305(1,000)
10		1/2.590	2.59	0.81	4.21	3.48	1,000	1,500	74.6	305(1,000)

- Remarks 1) Size range : UL 30-4/0AWG, CSA 22-4/0AWG
2) Allowable current : Ambient temperature 40°C, Max. allowable temperature 150°C, single-wire in air

2-12 Irradiated Wire

Lead Free Heat-resistant irradiated XLPE insulated wire

UL Style No.3398 CSA Type CL1252/AWM

- Rating UL : 300V, 150°C / CSA : 300V, 150°C
- Standard UL : UL Subject 758 / CSA : CSA C22.2 NO.210-2

Application

Internal wiring of electrical and electronic equipments.

Features

1. Standard : For both UL and CSA
2. Flame retardant : UL VW-1, Material Control Law -F-
3. Thermally stable due to radiation cross-linking, thus insulation does not melt at 350°C (5 sec or less).
4. EU Directive RoHS : Restricted use of Pb, Cd, Hg, Cr+6, PBBs, PBDEs

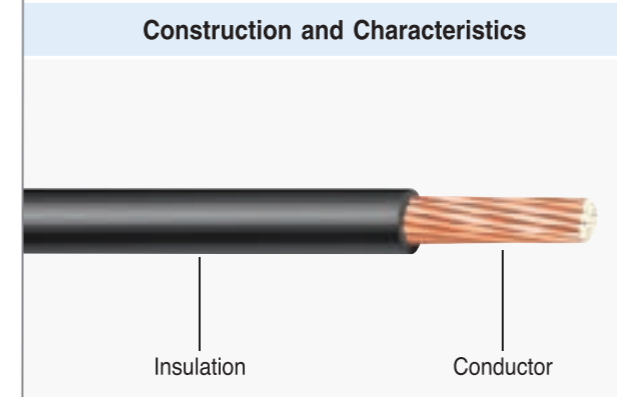

Marking

3398 E52853 VW-1 AWM 150C LL57183 CSA CL1252 XLPE 150C 300V FT1 AWG NO. LS Cable -F- LF

Type	Conductor			Insulation		Max. Cond. Resistance (20°C) (Ω/km)	Min. Insulation Resistance (15.6°C) (MΩ·km)	Dielectric Strength (AC) (V/1min)	Allowable Current (reference) (A)	Unit Length (m) (ft)
	Size (AWG)	Construction (No./mm)	Diameter (mm)	Nominal Thickness (mm)	Diameter (mm)					
Stranded	28	7/0.127	0.38	0.40	1.18	239.00	1,000	2,000	4.1	610(2,000)
	26	7/0.160	0.48	0.40	1.28	150.00	1,000	2,000	5.5	610(2,000)
	24	11/0.160	0.61	0.40	1.41	94.20	1,000	2,000	7.3	610(2,000)
	22	17/0.160	0.76	0.40	1.56	59.40	1,000	2,000	9.7	610(2,000)
	20	26/0.160	0.94	0.46	1.86	36.70	1,000	2,000	12.8	610(2,000)
	18	41/0.160	1.18	0.46	2.10	23.20	1,000	2,000	17.1	305(1,000)
	16	26/0.254	1.49	0.46	2.41	14.60	1,000	2,000	22.8	305(1,000)
	Solid	28	1/0.320	0.32	0.40	1.12	227.00	1,000	2,000	4.1
26		1/0.404	0.40	0.40	1.20	143.00	1,000	2,000	5.5	610(2,000)
24		1/0.511	0.51	0.40	1.31	89.30	1,000	2,000	7.3	610(2,000)
22		1/0.643	0.64	0.40	1.44	56.40	1,000	2,000	9.7	610(2,000)
20		1/0.813	0.81	0.46	1.73	35.20	1,000	2,000	12.8	610(2,000)
18		1/1.024	1.02	0.46	1.94	22.20	1,000	2,000	17.1	305(1,000)
16		1/1.290	1.29	0.46	2.21	14.00	1,000	2,000	22.8	305(1,000)
TA-SC		26	7/0.160	0.48	0.40	1.28	150.00	1,000	2,000	5.5
	24	7/0.203	0.61	0.40	1.41	94.20	1,000	2,000	7.3	610(2,000)
	22	7/0.254	0.76	0.40	1.56	59.40	1,000	2,000	9.7	610(2,000)

- Remarks 1) Size range : UL 32-10AWG, CSA : CL1252 22-16AWG, AWM 32-10AWG
2) Allowable current : Ambient temperature 40°C, Max. allowable temperature 150°C, single-wire in air

2-13 Irradiated Wire

Lead Free Flexible high voltage wire

3, 6kVDC UL Style No.3239

- Rating UL : 3,6kVDC, 105°C
- Standard UL : UL Subject 758

Application

Internal wiring of electronic equipment such as LCD back light.

Features

1. Flame retardant : UL VW-1, Material Control Law -F-
2. EU Directive RoHS : Restricted use of Pb, Cd, Hg, Cr+6, PBBs, PBDEs

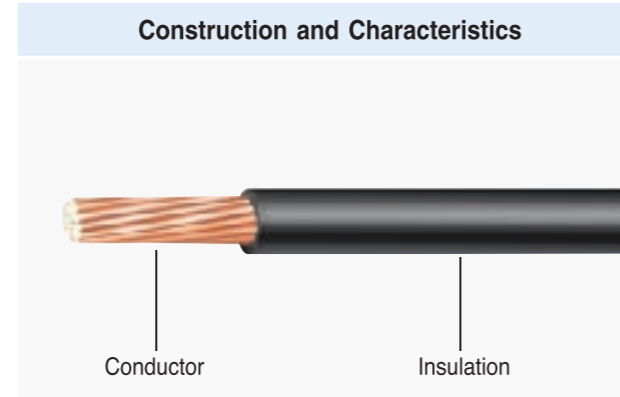

Marking

3239 E52853 VW-1  AWM 3, 6kVDC 105C AWG NO. LS Cable -F- ND

Rating Volt.	Conductor			Insulation		Max. Cond. Resistance (20°C) (Ω/km)	Min. Insulation Resistance (15.6°C) (MΩ·km)	Dielectric Strength (AC) (V/1min)	Unit Length (m) (ft)
	Size (AWG)	Construction (No./mm)	Diameter (mm)	Nominal Thickness (mm)	Diameter (mm)				
3kVDC	24	19/0.127	0.64	0.48	1.60	89.80	1,000	7,000	610(2,000)
	22	19/0.160	0.80	0.48	1.76	58.10	1,000	7,000	610(2,000)
	20	1/0.813	0.81	0.48	1.77	35.00	1,000	7,000	610(2,000)
6kVDC	24	19/0.127	0.64	0.55	1.74	89.80	1,000	7,000	610(2,000)
	22	19/0.160	0.80	0.55	1.90	58.10	1,000	7,000	610(2,000)
	20	1/0.813	0.81	0.55	1.91	35.00	1,000	7,000	610(2,000)

2-14 Irradiated Wire

Lead Free Flexible high voltage wire

UL Style No. 3633, 3613

- Rating UL : 3kVAC, 150°C
- Standard UL : UL Subject 758

Application

Internal wiring of electronic equipment such as LCD back light.

Features

1. Flame retardant : UL VW-1, Material Control Law -F-
2. EU Directive RoHS : Restricted use of Pb, Cd, Hg, Cr+6, PBBs, PBDEs

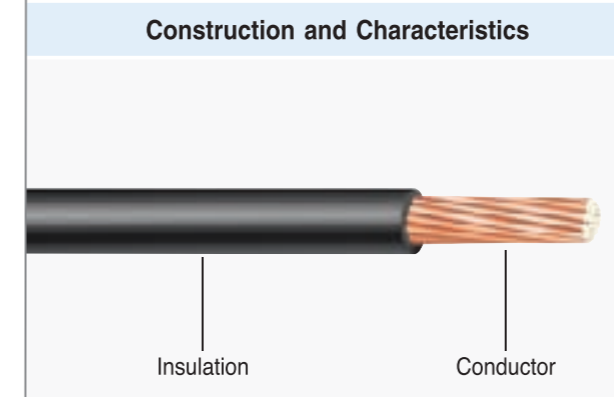

Marking

3633(3613) E52853 VW-1  AWM 3kVAC 150C AWG NO. LS Cable -F- ND

Style No.	Conductor			Insulation		Max. Cond. Resistance (20°C) (Ω/km)	Min. Insulation Resistance (15.6°C) (MΩ·km)	Dielectric Strength (AC) (V/1min)	Unit Length (m) (ft)
	Size (AWG)	Construction (No./mm)	Diameter (mm)	Nominal Thickness (mm)	Diameter (mm)				
3633	28	19/0.080	0.40	0.34	1.08	223.00	100	7,000	610(2,000)
	28	7/0.127	0.38	0.34	1.06	223.00	100	7,000	610(2,000)
	26	7/0.160	0.48	0.34	1.16	89.80	100	7,000	610(2,000)
	24	19/0.127	0.64	0.34	1.32	58.10	100	7,000	610(2,000)
	24	19/0.127	0.64	0.34	1.32	58.10	100	7,000	610(2,000)
3613	28	19/0.080	0.40	0.50	1.40	223.00	100	7,000	610(2,000)
	28	7/0.127	0.38	0.50	1.38	223.00	100	7,000	610(2,000)
	26	7/0.160	0.48	0.50	1.48	139.00	100	7,000	610(2,000)
	24	19/0.127	0.64	0.50	1.64	89.80	100	7,000	610(2,000)
	22	19/0.160	0.80	0.50	1.80	58.10	100	7,000	610(2,000)

► Remarks 1) Size range : UL 30-10AWG

3-1 Halogen Free Irradiated Wire

Halogen Free Heat-resistant irradiated XLPE insulated wire

UL Style No. 10368

- Rating UL : 300V, 105°C / CSA : 300V, 105°C
- Standard UL : UL Subject 758 / CSA : CSA C22.2 NO.127

Application

Internal wiring of electrical and electronic equipments.

Features

1. Flame retardant : UL VW-1, CSA FT1, Material Control Law -F-
2. Small diameter saves space.
3. EU Directive RoHS : Restricted use of Pb, Cd, Hg, Cr+6, PBBs, PBDEs

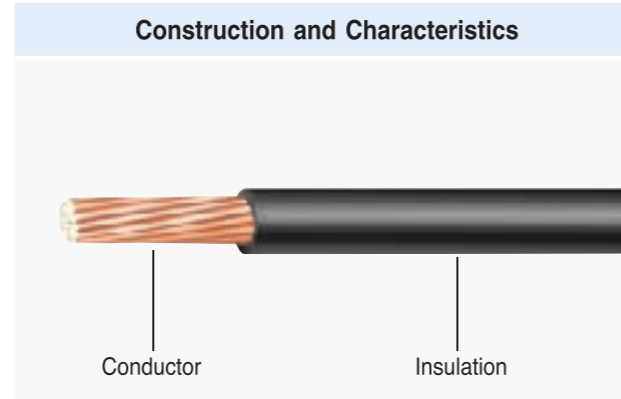

Marking

10368 E52853  AWM I A/B 105C 300V VW-1 AWG NO. LS Cable -F- HF

Type	Conductor			Insulation		Max. Cond. Resistance (20°C) (Ω/km)	Min. Insulation Resistance (15.6°C) (MΩ·km)	Dielectric Strength (AC) (V/1min)	Allowable Current (reference) (A)	Unit Length (m) (ft)
	Size (AWG)	Construction (No./mm)	Diameter (mm)	Nominal Thickness (mm)	Diameter (mm)					
Stranded	28	7/0.127	0.38	0.25	0.88	239.00	10	2,000	2.7	1,220(4,000)
	26	7/0.160	0.48	0.25	0.98	150.00	10	2,000	3.8	1,220(4,000)
	24	7/0.203	0.61	0.25	1.11	94.20	10	2,000	5.1	610(2,000)
	22	7/0.254	0.76	0.25	1.26	59.40	10	2,000	7.1	610(2,000)
	20	19/0.203	1.02	0.25	1.52	36.70	10	2,000	9.5	610(2,000)

► Remarks 1) Size range : UL 40-10AWG

3-2 Halogen Free Irradiated Wire

Halogen Free Heat-resistant irradiated XLPE insulated wire

UL Style No. 3275

- Rating UL : 1,000V, 105°C / CSA : 1,000V, 105°C
- Standard UL : UL Subject 758 / CSA : CSA C22.2 NO.127

Application

Internal wiring of electrical and electronic equipments.

Features

1. Flame retardant : UL VW-1, CSA FT1, Material Control Law -F-
2. Small diameter saves space.
3. EU Directive RoHS : Restricted use of Pb, Cd, Hg, Cr+6, PBBs, PBDEs

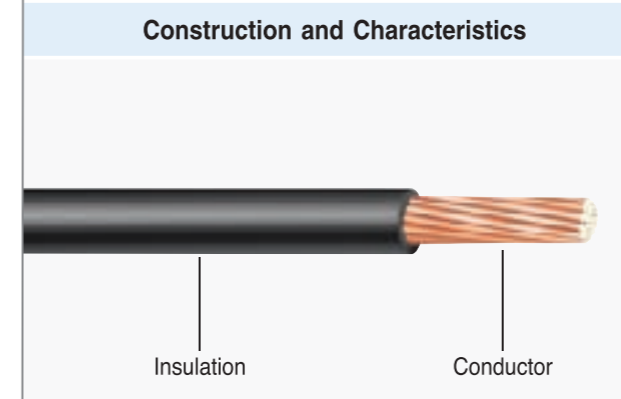

Marking

3275 E52853  AWM I A/B 105C 1000V VW-1 AWG NO. LS Cable -F- HF

Type	Conductor			Insulation		Max. Cond. Resistance (20°C) (Ω/km)	Min. Insulation Resistance (15.6°C) (MΩ·km)	Dielectric Strength (AC) (V/1min)	Allowable Current (reference) (A)	Unit Length (m) (ft)
	Size (AWG)	Construction (No./mm)	Diameter (mm)	Nominal Thickness (mm)	Diameter (mm)					
Stranded	24	11/0.160	0.61	0.80	2.21	94.20	15	3,000	6.6	305(1,000)
	22	17/0.160	0.76	0.80	2.36	59.40	15	3,000	8.7	305(1,000)
	20	26/0.160	0.94	0.80	2.54	36.70	15	3,000	11.4	305(1,000)
	18	41/0.160	1.18	0.80	2.78	23.20	15	3,000	15.0	305(1,000)
	16	26/0.254	1.49	0.80	3.09	14.60	15	3,000	19.9	305(1,000)
	14	41/0.254	1.88	0.80	3.48	8.96	15	3,000	26.5	305(1,000)
	12	65/0.254	2.36	0.80	3.96	5.64	15	3,000	35.4	305(1,000)
	10	66/0.320	3.00	0.80	4.60	3.55	15	3,000	48.2	305(1,000)
	Solid	24	1/0.511	0.51	0.80	2.11	89.30	15	3,000	6.6
22		1/0.643	0.64	0.80	2.24	56.40	15	3,000	8.7	305(1,000)
20		1/0.813	0.81	0.80	2.41	35.20	15	3,000	11.4	305(1,000)
18		1/1.024	1.02	0.80	2.62	22.20	15	3,000	15.0	305(1,000)
16		1/1.290	1.29	0.80	2.89	14.00	15	3,000	19.9	305(1,000)
14		1/1.630	1.63	0.80	3.23	8.78	15	3,000	26.5	305(1,000)
12		1/2.050	2.05	0.80	3.65	5.53	15	3,000	35.4	305(1,000)
TA-SC	22	7/0.254	0.76	0.80	2.36	59.40	15	3,000	8.7	305(1,000)
	20	7/0.320	0.96	0.80	2.56	36.70	15	3,000	11.4	305(1,000)

► Remarks 1) Size range : UL 26-9AWG

3-3 Halogen Free Irradiated Wire

Halogen Free Heat-resistant irradiated XLPE insulated wire

UL Style No. 3302

- Rating UL : 30V, 105°C
- Standard UL : UL Subject 758

Application

Internal wiring of electrical and electronic equipments.

Features

1. Flame retardant : UL VW-1, Material Control Law -F-
2. Small diameter saves space.
3. EU Directive RoHS : Restricted use of Pb, Cd, Hg, Cr+6, PBBs, PBDEs

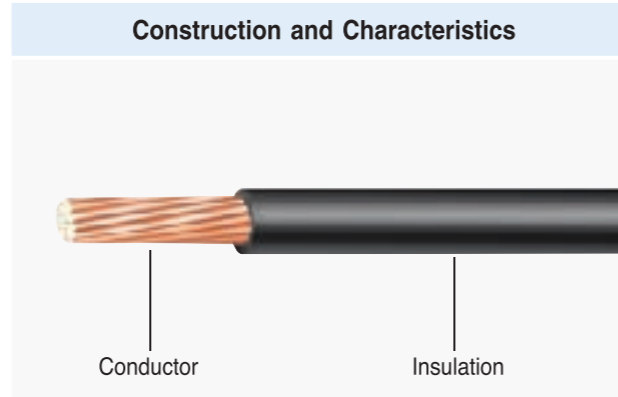

Marking

3302 E52853  AWM 105C 30V VW-1 AWG NO. LS Cable -F- HF

Type	Conductor			Insulation		Max. Cond. Resistance (20°C) (Ω/km)	Min. Insulation Resistance (15.6°C) (MΩ·km)	Dielectric Strength (AC) (V/1min)	Allowable Current (reference) (A)	Unit Length (m) (ft)
	Size (AWG)	Construction (No./mm)	Diameter (mm)	Nominal Thickness (mm)	Diameter (mm)					
Stranded	28	7/0.127	0.38	0.25	0.88	239.00	10	500	2.7	1,220(4,000)
	26	7/0.160	0.48	0.25	0.98	150.00	10	500	3.8	1,220(4,000)
	24	7/0.203	0.61	0.25	1.11	94.20	10	500	5.1	610(2,000)

► Remarks 1) Size range : Min. 40AWG

3-4 Halogen Free Irradiated Wire

Halogen Free Heat-resistant irradiated XLPE insulated wire

UL Style No. 3385

- Rating UL : 300V, 105°C / CSA : 300V, 105°C
- Standard UL : UL Subject 758 / CSA : CSA C22.2 NO.127

Application

Internal wiring of electrical and electronic equipments.

Features

1. Flame retardant : UL VW-1, CSA FT1, Material Control Law -F-
2. Small diameter saves space.
3. EU Directive RoHS : Restricted use of Pb, Cd, Hg, Cr+6, PBBs, PBDEs

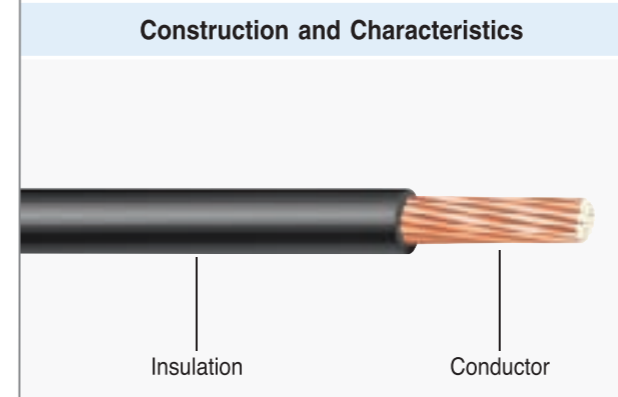

Marking

3385 E52853  AWM I A/B 105C 300V VW-1 AWG NO. LS Cable -F- HF

Type	Conductor			Insulation		Max. Cond. Resistance (20°C) (Ω/km)	Min. Insulation Resistance (15.6°C) (MΩ·km)	Dielectric Strength (AC) (V/1min)	Allowable Current (reference) (A)	Unit Length (m) (ft)
	Size (AWG)	Construction (No./mm)	Diameter (mm)	Nominal Thickness (mm)	Diameter (mm)					
Stranded	30	7/0.102	0.31	0.42	1.15	381.00	10	2,000	2.3	610(2,000)
	28	7/0.127	0.38	0.42	1.22	239.00	10	2,000	3.0	610(2,000)
	26	7/0.160	0.48	0.42	1.32	150.00	10	2,000	4.0	610(2,000)
	24	11/0.160	0.61	0.42	1.45	94.20	10	2,000	5.3	610(2,000)
	22	17/0.160	0.76	0.42	1.60	59.40	10	2,000	7.2	610(2,000)
	20	26/0.160	0.94	0.42	1.78	36.70	10	2,000	9.4	610(2,000)
	18	41/0.160	1.18	0.42	2.02	23.20	10	2,000	12.5	305(1,000)
	16	26/0.254	1.49	0.42	2.33	14.60	10	2,000	15.9	305(1,000)
Solid	30	1/0.254	0.26	0.42	1.10	361.00	10	2,000	2.3	610(2,000)
	28	1/0.320	0.32	0.42	1.16	227.00	10	2,000	3.0	610(2,000)
	26	1/0.404	0.40	0.42	1.24	143.00	10	2,000	4.0	610(2,000)
	24	1/0.511	0.51	0.42	1.35	89.30	10	2,000	5.3	610(2,000)
	22	1/0.643	0.64	0.42	1.48	56.40	10	2,000	7.2	610(2,000)
	20	1/0.813	0.81	0.42	1.65	35.20	10	2,000	9.4	610(2,000)
	18	1/1.024	1.02	0.42	1.86	22.20	10	2,000	12.5	305(1,000)
TA-SC	26	7/0.160	0.48	0.42	1.32	150.00	10	2,000	4.0	610(2,000)
	24	7/0.203	0.61	0.42	1.45	94.20	10	2,000	5.3	610(2,000)
	22	7/0.254	0.76	0.42	1.60	59.40	10	2,000	7.2	610(2,000)

► Remarks 1) Size range : UL 32-10AWG

3-5 Halogen Free Irradiated Wire

Halogen Free Heat-resistant irradiated XLPE insulated wire

UL Style No. 3386

- Rating UL : 600V, 105°C / 600V, 105°C
- Standard UL : UL Subject 758 / CSA : CSA C22.2 NO.127

Application

Internal wiring of electrical and electronic equipments.

Features

1. Flame retardant : UL VW-1, CSA FT1, Material Control Law -F-
2. Small diameter saves space.
3. EU Directive RoHS : Restricted use of Pb, Cd, Hg, Cr+6, PBBs, PBDEs

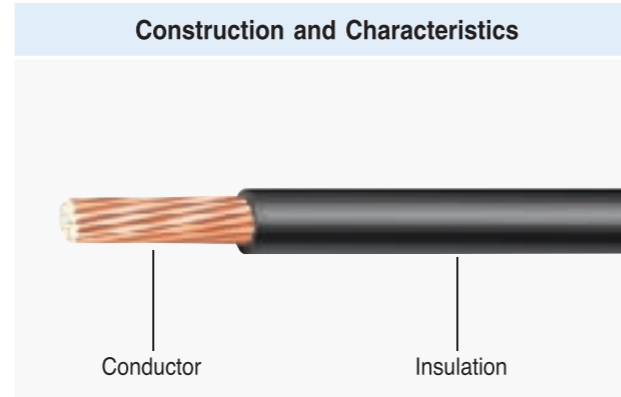

Marking

3386 E52853  AWM I A/B 105C 600V VW-1 AWG NO. LS Cable -F- HF

Type	Conductor			Insulation		Max. Cond. Resistance (20°C) (Ω/km)	Min. Insulation Resistance (15.6°C) (MΩ·km)	Dielectric Strength (AC) (V/1min)	Allowable Current (reference) (A)	Unit Length (m) (ft)
	Size (AWG)	Construction (No./mm)	Diameter (mm)	Nominal Thickness (mm)	Diameter (mm)					
Stranded	26	7/0.160	0.48	0.80	2.08	150.00	15	2,000	5.8	305(1,000)
	24	11/0.160	0.61	0.80	2.21	94.20	15	2,000	7.6	305(1,000)
	22	17/0.160	0.76	0.80	2.36	59.40	15	2,000	10.0	305(1,000)
	20	26/0.160	0.94	0.80	2.54	36.70	15	2,000	13.1	305(1,000)
	18	41/0.160	1.18	0.80	2.78	23.20	15	2,000	17.2	305(1,000)
	16	26/0.254	1.49	0.80	3.09	14.60	15	2,000	22.8	305(1,000)
	14	41/0.254	1.88	0.80	3.48	8.96	15	2,000	30.4	305(1,000)
	12	65/0.254	2.36	0.80	3.96	5.64	15	2,000	40.6	305(1,000)
Solid	26	1/0.404	0.40	0.80	2.00	143.00	15	2,000	5.8	305(1,000)
	24	1/0.511	0.51	0.80	2.11	89.30	15	2,000	7.6	305(1,000)
	22	1/0.643	0.64	0.80	2.24	56.40	15	2,000	10.0	305(1,000)
	20	1/0.813	0.81	0.80	2.41	35.20	15	2,000	13.1	305(1,000)
	18	1/1.024	1.02	0.80	2.62	22.20	15	2,000	17.2	305(1,000)
	16	1/1.290	1.29	0.80	2.89	14.00	15	2,000	22.8	305(1,000)
	14	1/1.630	1.63	0.80	3.23	8.78	15	2,000	30.4	305(1,000)
	12	1/2.050	2.05	0.80	3.65	5.53	15	2,000	40.6	305(1,000)
TA-SC	24	7/0.203	0.61	0.80	2.21	94.20	15	2,000	7.6	305(1,000)
	22	7/0.254	0.76	0.80	2.36	59.40	15	2,000	10.0	305(1,000)

► Remarks 1) Size range : UL 32-4/AWG

3-6 Halogen Free Irradiated Wire

Halogen Free Heat-resistant irradiated XLPE insulated wire

UL Style No. 3619

- Rating UL : 150V, 105°C / CSA : 150V, 105°C
- Standard UL : UL Subject 758 / CSA : CSA C22.2 NO.127

Application

Internal wiring of electrical and electronic equipments.

Features

1. Flame retardant : UL VW-1, CSA FT1, Material Control Law -F-
2. Small diameter saves space.
3. EU Directive RoHS : Restricted use of Pb, Cd, Hg, Cr+6, PBBs, PBDEs

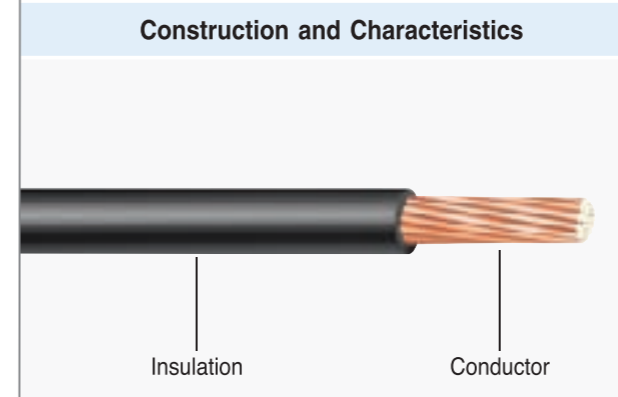

Marking

3619 E52853  AWM 105C 150V VW-1 AWG NO. LS Cable -F- HF

Type	Conductor			Insulation		Max. Cond. Resistance (20°C) (Ω/km)	Min. Insulation Resistance (15.6°C) (MΩ·km)	Allowable Current (reference) (A)	Unit Length (m) (ft)
	Size (AWG)	Construction (No./mm)	Diameter (mm)	Nominal Thickness (mm)	Diameter (mm)				
Stranded	26	7/0.160	0.48	0.20	0.88	150.00	10	1,500	1,220(4,000)

4-1 High Voltage TV Wire

Lead Free High voltage wire
for internal wiring of TV

UL Style No.3239 CSA TV-10~50

- Rating UL : 10~50kVDC, 105°C / CSA : 10~50kVDC, 105°C
- Standard UL : UL Subject 758 / CSA : CSA C22.2 NO.127

Application

Internal wiring of high voltage electrical and electronic equipments such as TV, microwave ovens and FBT. etc.

Features

1. Flame retardant : UL VW-1
2. Excellent electrical characteristics such as dielectric strength.
3. Excellent flexibility.
4. Excellent stripping and adhesion between insulation and conductor.
5. EU Directive RoHS : Restricted use of Pb, Cd, Hg, Cr+6, PBBs, PBDEs

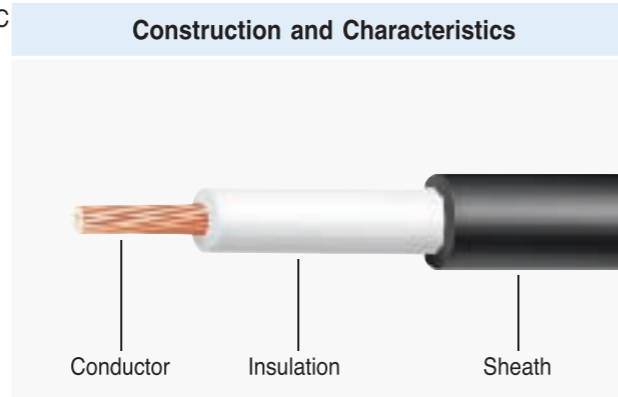

Marking

3239 E52853 VW-1 AWM 20KVDC 105C LL33908 CSA TV-20 XLHDPE 105C FT1 AWG NO. LS Cable -F- LF

CSA Type	Rating		Conductor			Insulation		Sheath			Max. Cond. Resistance (20°C)	Dielectric Strength (AC) (V/1min)	Unit Length (m) (ft)
	Temp. (°C)	Volt. (kVDC)	Size (AWG)	Construction (No./mm)	Diameter (mm)	Nominal Thickness (mm)	Diameter (mm)	Nominal Thickness (mm)	Diameter (mm)	Color			
TV-10	105	10	22	7/0.254	0.762	0.32	1.40	0.40	2.20	WH RD BK	54.70	15	305(1,000)
TV-20	105	20	22	7/0.254	0.762	0.68	2.12	0.54	3.20		54.70	30	305(1,000)
TV-20	105	20	18	19/0.254	1.270	0.68	2.63	0.57	3.77		20.30	30	305(1,000)
TV-30	105	30	22	7/0.254	0.762	0.68	2.12	0.66	3.44		54.70	45	305(1,000)
TV-40	105	40	22	7/0.254	0.762	1.02	2.80	0.70	4.20		54.70	60	305(1,000)
TV-50	105	50	22	7/0.254	0.762	1.20	3.16	1.02	5.20	54.70	75	305(1,000)	
TV-20	105	20	20	1/0.813	0.813	0.67	2.15	0.54	3.23	WH RD BK	35.00	30	305(1,000)
TV-20	105	20	20	1/0.813	0.813	0.62	2.05	0.52	3.09		35.00	30	305(1,000)
TV-30	105	30	20	1/0.813	0.813	0.67	2.15	0.67	3.49		35.00	45	305(1,000)
TV-40	105	40	20	1/0.813	0.813	1.00	2.81	0.70	4.21		35.00	60	305(1,000)
TV-50	105	50	20	1/0.813	0.813	1.11	3.03	1.09	5.21		35.00	75	305(1,000)

- Remarks 1) Conductor : Tin coated soft annealed copper wire
2) Insulation : XLPE
3) Sheath : XLPVC
4) Insulation resistance : more than 1,000M Ω ·km

4-2 High Voltage TV Wire

Lead Free High voltage wire
for internal wiring of TV (Single insulation type)

UL Style No.3476 CSA TV-6

- Rating UL : 3kVDC, 105°C / CSA : 6kVDC, 80°C
- Standard UL : UL Subject 758 / CSA : CSA C22.2 NO.127

Application

Internal wiring of high voltage electrical and electronic equipments such as TV, microwave ovens and FBT. etc.

Features

1. Flame retardant : UL VW-1
2. Excellent electrical characteristics such as dielectric strength.
3. Excellent handling of connection.
4. Excellent stripping and adhesion between insulation and conductor.
5. EU Directive RoHS : Restricted use of Pb, Cd, Hg, Cr+6, PBBs, PBDEs

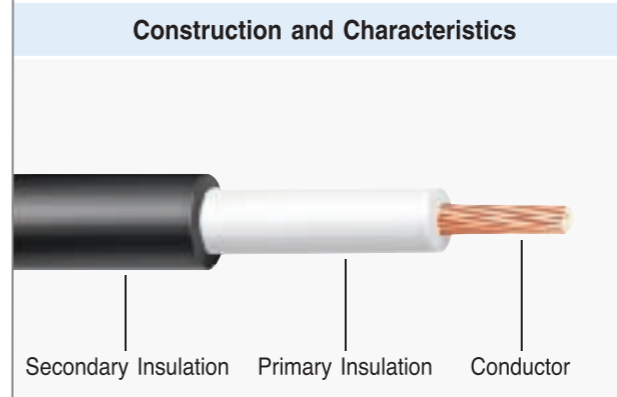

Marking

3476 E52853 VW-1 AWM 3KVDC 105C LL33908 CSA TV-6 XLPVC FT1 80C AWG NO. LS Cable -F- LF

Size (AWG)	Conductor		Insulation		Max. Cond. Resistance (20°C) (Ω /km)	Min. Insulation Resistance (15.6°C) (M Ω ·km)	Dielectric Strength (AC) (V/1min)	Allowable Current (reference) (A)	Unit Length (m) (ft)
	Construction (No./mm)	Diameter (mm)	Nominal Thickness (mm)	Diameter (mm)					
22	7/0.254	0.76	0.85	2.46	54.70	15.00	6.00	59.40	305(1,000)
22	1/0.643	0.64	0.85	2.34	56.30	15.00	6.00	56.40	305(1,000)
20	1/0.813	0.81	0.85	2.51	35.00	15.00	6.00	35.20	305(1,000)

- Remarks 1) Conductor : Tin coated soft annealed copper wire
2) Insulation : XLPVC
3) Insulation resistance : more than 15M Ω ·km

5-1 Fluoropolymer Wire

Fluoropolymer (PVDF) insulated wire

UL Style No.1422

- Rating UL : 105°C
- Standard UL : UL Subject 758

Application

1. Internal wiring of small electrical and electronic equipments.
2. Internal wiring of computer and business equipments.

Features

1. Flame retardant : UL VW-1
2. Small diameter saves space.
3. Excellent mechanical strength such as abrasion and cut-through resistance.
4. EU Directive RoHS : Restricted use of Pb, Cd, Hg, Cr+6, PBBs, PBDEs.

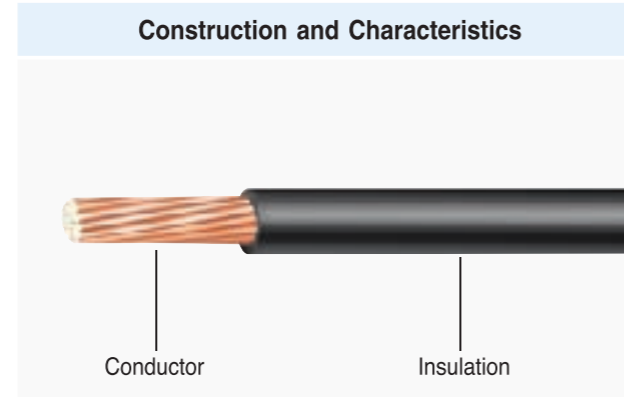

Type	Conductor			Insulation		Max. Cond. Resistance (20°C) (Ω/km)	Min. Insulation Resistance (15.6°C) (MΩ·km)	Dielectric Strength (AC) (V/1min)	Allowable Current (reference) (A)	Unit Length (m) (ft)
	Size (AWG)	Construction (No./mm)	Diameter (mm)	Nominal Thickness (mm)	Diameter (mm)					
Stranded	30	7/0.102	0.31	0.14	0.59	354.00	30.00	500	1.5	610(2,000)
	28	7/0.127	0.38	0.14	0.66	223.00	30.00	500	2.0	610(2,000)
	26	7/0.160	0.48	0.14	0.76	139.00	30.00	500	3.0	610(2,000)
	24	7/0.203	0.61	0.14	0.89	85.90	30.00	500	4.0	610(2,000)
	22	7/0.254	0.76	0.14	1.04	54.70	30.00	500	6.0	610(2,000)
	20	7/0.320	0.96	0.14	1.24	34.40	30.00	500	9.0	610(2,000)
Solid	30	1/0.254	0.25	0.14	0.53	373.00	30.00	500	1.5	610(2,000)
	28	1/0.320	0.32	0.14	0.60	232.00	30.00	500	2.0	610(2,000)
	26	1/0.404	0.40	0.14	0.68	145.00	30.00	500	3.0	610(2,000)
	24	1/0.511	0.51	0.14	0.79	89.10	30.00	500	4.0	610(2,000)
	22	1/0.643	0.64	0.14	0.92	56.30	30.00	500	6.0	610(2,000)
	20	1/0.813	0.81	0.14	1.09	35.00	30.00	500	9.0	610(2,000)
TA-SC	28	7/0.127	0.38	0.14	0.66	223.00	30.00	500	2.0	610(2,000)
	26	7/0.160	0.48	0.14	0.76	139.00	30.00	500	3.0	610(2,000)
	24	7/0.203	0.61	0.14	0.89	85.90	30.00	500	4.0	610(2,000)
	22	7/0.254	0.76	0.14	1.04	54.70	30.00	500	6.0	610(2,000)

- Remarks 1) Allowable current : Ambient temperature 40°C, Max. allowable temperature 105°C, single-wire in air
2) Conductor : Tin coated soft annealed copper wire, TA-SC

5-2 Fluoropolymer Wire

Fluoropolymer (PVDF) insulated wire

UL Style No.1426

- Rating UL : 105°C
- Standard UL : UL Subject 758

Application

1. Internal wiring of small electrical and electronic equipments.
2. Internal wiring of computer and business equipments.

Features

1. Flame retardant : UL VW-1
2. Small diameter saves space.
3. Excellent mechanical strength such as abrasion and cut-through resistance.
4. EU Directive RoHS : Restricted use of Pb, Cd, Hg, Cr+6, PBBs, PBDEs

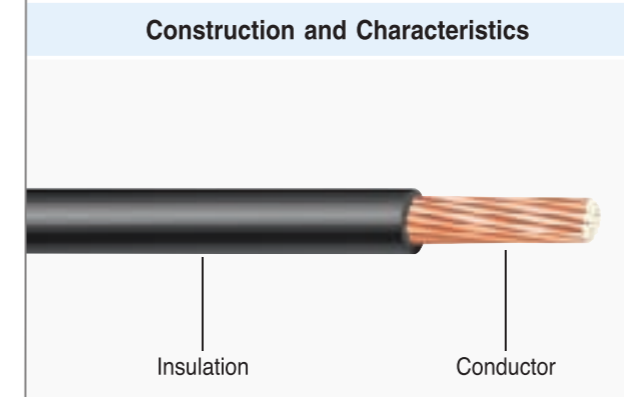

Type	Conductor			Insulation		Max. Cond. Resistance (20°C) (Ω/km)	Min. Insulation Resistance (15.6°C) (MΩ·km)	Dielectric Strength (AC) (V/1min)	Allowable Current (reference) (A)	Unit Length (m) (ft)
	Size (AWG)	Construction (No./mm)	Diameter (mm)	Nominal Thickness (mm)	Diameter (mm)					
Stranded	30	7/0.102	0.31	0.17	0.65	354.00	30.00	500	1.5	610(2,000)
	28	7/0.127	0.38	0.17	0.72	223.00	30.00	500	2.0	610(2,000)
	26	7/0.160	0.48	0.17	0.82	139.00	30.00	500	3.0	610(2,000)
	24	7/0.203	0.61	0.17	0.95	85.90	30.00	500	4.0	610(2,000)
	22	7/0.254	0.76	0.17	1.10	54.70	30.00	500	6.0	610(2,000)
	20	7/0.320	0.96	0.17	1.30	34.40	30.00	500	9.0	610(2,000)
Solid	30	1/0.254	0.25	0.17	0.59	373.00	30.00	500	1.5	610(2,000)
	28	1/0.320	0.32	0.17	0.66	232.00	30.00	500	2.0	610(2,000)
	26	1/0.404	0.40	0.17	0.74	145.00	30.00	500	3.0	610(2,000)
	24	1/0.511	0.51	0.17	0.85	89.10	30.00	500	4.0	610(2,000)
	22	1/0.643	0.64	0.17	0.98	56.30	30.00	500	6.0	610(2,000)
	20	1/0.813	0.81	0.17	1.15	35.00	30.00	500	9.0	610(2,000)
TA-SC	28	7/0.127	0.38	0.17	0.72	223.00	30.00	500	2.0	610(2,000)
	26	7/0.160	0.48	0.17	0.82	139.00	30.00	500	3.0	610(2,000)
	24	7/0.203	0.61	0.17	0.95	85.90	30.00	500	4.0	610(2,000)
	22	7/0.254	0.76	0.17	1.10	54.70	30.00	500	6.0	610(2,000)

- Remarks 1) Allowable current : Ambient temperature 40°C, Max. allowable temperature 105°C, single-wire in air
2) Conductor : Tin coated soft annealed copper wire, TA-SC

5-3 Fluoropolymer Wire

Fluoropolymer (ETFE) insulated wire

UL Style No.1508

- Rating UL : 30V, 105°C
- Standard UL : UL Subject 758

Application

1. Internal wiring of small electrical and electronic equipments.
2. Internal wiring of computer and business and audio/video equipments.

Features

1. Flame retardant : UL VW-1
2. Small diameter saves space.
3. Excellent electric characteristics and mechanical strength.
4. Excellent low temperature characteristics.
5. EU Directive RoHS : Restricted use of Pb, Cd, Hg, Cr+6, PBBs, PBDEs

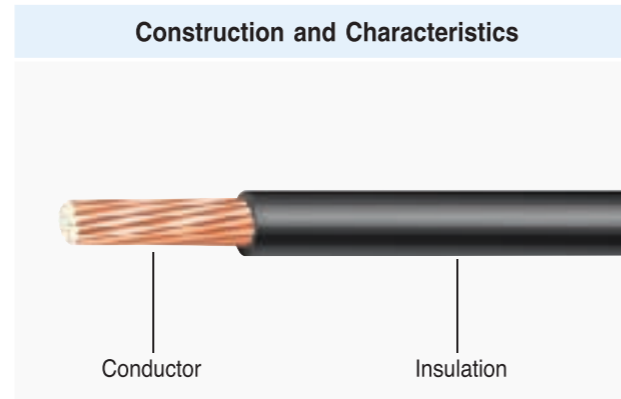

Type	Conductor			Insulation		Max. Cond. Resistance (20°C) (Ω/km)	Min. Insulation Resistance (15.6°C) (MΩ·km)	Dielectric Strength (AC) (V/1min)	Allowable Current (reference) (A)	Unit Length (m) (ft)
	Size (AWG)	Construction (No./mm)	Diameter (mm)	Nominal Thickness (mm)	Diameter (mm)					
Stranded	30	7/0.102	0.31	0.15	0.61	354.00	30.00	500	1.5	610(2,000)
	28	7/0.127	0.38	0.15	0.68	223.00	30.00	500	2.0	610(2,000)
	26	7/0.160	0.48	0.15	0.78	139.00	30.00	500	3.0	610(2,000)
	24	7/0.203	0.61	0.15	0.91	85.90	30.00	500	4.0	610(2,000)
	22	7/0.254	0.76	0.15	1.06	54.70	30.00	500	6.0	610(2,000)
	20	7/0.320	0.96	0.15	1.26	34.40	30.00	500	9.0	610(2,000)
Solid	30	1/0.254	0.25	0.15	0.55	373.00	30.00	500	1.5	610(2,000)
	28	1/0.320	0.32	0.15	0.62	232.00	30.00	500	2.0	610(2,000)
	26	1/0.404	0.40	0.15	0.70	145.00	30.00	500	3.0	610(2,000)
	24	1/0.511	0.51	0.15	0.81	89.10	30.00	500	4.0	610(2,000)
	22	1/0.643	0.64	0.15	0.94	56.30	30.00	500	6.0	610(2,000)
	20	1/0.813	0.81	0.15	1.11	35.00	30.00	500	9.0	610(2,000)
TA-SC	28	7/0.127	0.38	0.15	0.68	223.00	30.00	500	2.0	610(2,000)
	26	7/0.160	0.48	0.15	0.78	139.00	30.00	500	3.0	610(2,000)
	24	7/0.203	0.61	0.15	0.91	85.90	30.00	500	4.0	610(2,000)
	22	7/0.254	0.76	0.15	1.06	54.70	30.00	500	6.0	610(2,000)

- Remarks 1) Allowable current : Ambient temperature 40°C, Max. allowable temperature 105°C, single-wire in air
 2) Conductor : Tin coated soft annealed copper wire, TA-SC
 3) UL1609 is included among UL1508.

Construction and performance of UL1670 are the same as UL1508, but rating(voltage, temperature) is different.
 UL1609 : 125V/105°C, UL1670 : 150°C, voltage is not specified.

5-4 Fluoropolymer Wire

Fluoropolymer (ETFE) insulated wire

UL Style No.1516

- Rating UL : 105°C
- Standard UL : UL Subject 758

Application

1. Internal wiring of small electrical and electronic equipments.
2. Internal wiring of computer, business and audio/video equipments.

Features

1. Flame retardant : UL VW-1
2. Small diameter saves space.
3. Excellent electric characteristics and mechanical strength.
4. Excellent low temperature characteristics.
5. EU Directive RoHS : Restricted use of Pb, Cd, Hg, Cr+6, PBBs, PBDEs

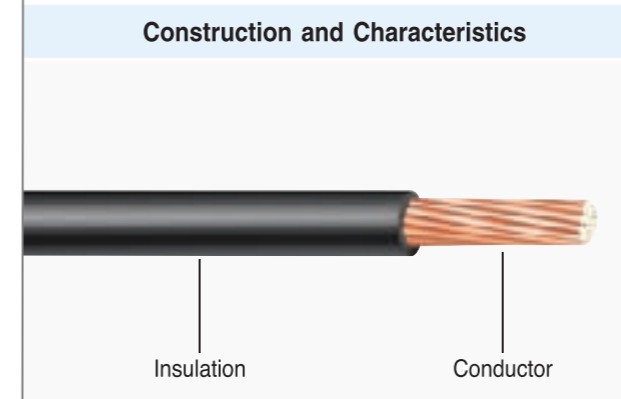

Type	Conductor			Insulation		Max. Cond. Resistance (20°C) (Ω/km)	Min. Insulation Resistance (15.6°C) (MΩ·km)	Dielectric Strength (AC) (V/1min)	Allowable Current (reference) (A)	Unit Length (m) (ft)
	Size (AWG)	Construction (No./mm)	Diameter (mm)	Nominal Thickness (mm)	Diameter (mm)					
Stranded	30	7/0.102	0.31	0.12	0.55	354.00	30.00	500	1.5	610(2,000)
	28	7/0.127	0.38	0.12	0.62	223.00	30.00	500	2.0	610(2,000)
	26	7/0.160	0.48	0.12	0.72	139.00	30.00	500	3.0	610(2,000)
	24	7/0.203	0.61	0.12	0.85	85.90	30.00	500	4.0	610(2,000)
	22	7/0.254	0.76	0.12	1.00	54.70	30.00	500	6.0	610(2,000)
	20	7/0.320	0.96	0.12	1.20	34.40	30.00	500	9.0	610(2,000)
Solid	30	1/0.254	0.25	0.12	0.49	373.00	30.00	500	1.5	610(2,000)
	28	1/0.320	0.32	0.12	0.56	232.00	30.00	500	2.0	610(2,000)
	26	1/0.404	0.40	0.12	0.64	145.00	30.00	500	3.0	610(2,000)
	24	1/0.511	0.51	0.12	0.75	89.10	30.00	500	4.0	610(2,000)
	22	1/0.643	0.64	0.12	0.88	56.30	30.00	500	6.0	610(2,000)
	20	1/0.813	0.81	0.12	1.11	35.00	30.00	500	9.0	610(2,000)
TA-SC	28	7/0.127	0.38	0.12	0.62	223.00	30.00	500	2.0	610(2,000)
	26	7/0.160	0.48	0.12	0.72	139.00	30.00	500	3.0	610(2,000)
	24	7/0.203	0.61	0.12	0.85	85.90	30.00	500	4.0	610(2,000)
	22	7/0.254	0.76	0.12	1.00	54.70	30.00	500	6.0	610(2,000)

- Remarks 1) Allowable current : Ambient temperature 40°C, Max. allowable temperature 105°C, single-wire in air
 2) Conductor : Tin coated soft annealed copper wire, TA-SC

5-5 Fluoropolymer Wire

Fluoropolymer (ETFE) insulated wire

UL Style No.1517

- Rating UL : 105°C
- Standard UL : UL Subject 758

Application

1. Internal wiring of small electrical and electronic equipments.
2. Internal wiring of computer, business and audio/video equipments.

Features

1. Flame retardant : UL VW-1
2. Small diameter saves space.
3. Excellent electric characteristics and mechanical strength.
4. Excellent low temperature characteristics.
5. EU Directive RoHS : Restricted use of Pb, Cd, Hg, Cr+6, PBBs, PBDEs

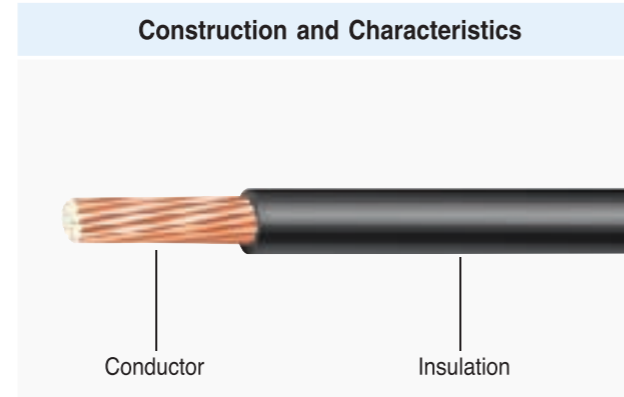

Type	Conductor			Insulation		Max. Cond. Resistance (20°C) (Ω/km)	Min. Insulation Resistance (15.6°C) (MΩ·km)	Dielectric Strength (AC) (V/1min)	Allowable Current (reference) (A)	Unit Length (m) (ft)
	Size (AWG)	Construction (No./mm)	Diameter (mm)	Nominal Thickness (mm)	Diameter (mm)					
Stranded	30	7/0.102	0.31	0.17	0.65	354.00	30	500	1.5	610(2,000)
	28	7/0.127	0.38	0.17	0.72	223.00	30	500	2.0	610(2,000)
	26	7/0.160	0.48	0.17	0.82	139.00	30	500	3.0	610(2,000)
	24	7/0.203	0.61	0.17	0.95	85.90	30	500	4.0	610(2,000)
	22	7/0.254	0.76	0.17	1.10	54.70	30	500	6.0	610(2,000)
	20	7/0.320	0.96	0.17	1.30	34.40	30	500	9.0	610(2,000)
Solid	30	1/0.254	0.25	0.17	0.59	373.00	30	500	1.5	610(2,000)
	28	1/0.320	0.32	0.17	0.66	232.00	30	500	2.0	610(2,000)
	26	1/0.404	0.40	0.17	0.74	145.00	30	500	3.0	610(2,000)
	24	1/0.511	0.51	0.17	0.85	89.10	30	500	4.0	610(2,000)
	22	1/0.643	0.64	0.17	0.98	56.30	30	500	6.0	610(2,000)
TA-SC	28	7/0.127	0.38	0.17	0.72	223.00	30	500	2.0	610(2,000)
	26	7/0.160	0.48	0.17	0.82	139.00	30	500	3.0	610(2,000)
	24	7/0.203	0.61	0.17	0.95	85.90	30	500	4.0	610(2,000)
	22	7/0.254	0.76	0.17	1.10	54.70	30	500	6.0	610(2,000)

- Remarks 1) Allowable current : Ambient temperature 40°C, Max. allowable temperature 105°C, single-wire in air
2) Conductor : Tin coated soft annealed copper wire, TA-SC

5-6 Fluoropolymer Wire

Fluoropolymer (ETFE) insulated wire

UL Style No.1610

- Rating UL : 105°C
- Standard UL : UL Subject 758

Application

1. Internal wiring of small electrical and electronic equipments.
2. Internal wiring of computer, business and audio/video equipments.

Features

1. Flame retardant : UL VW-1
2. Small diameter saves space.
3. Excellent electric characteristics and mechanical strength.
4. Excellent low temperature characteristics.
5. EU Directive RoHS : Restricted use of Pb, Cd, Hg, Cr+6, PBBs, PBDEs

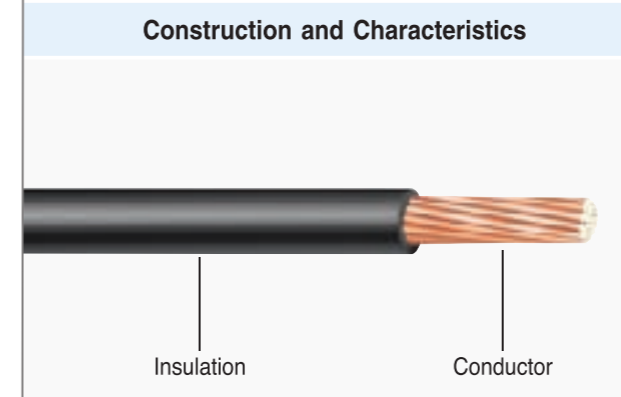

Type	Conductor			Insulation		Max. Cond. Resistance (20°C) (Ω/km)	Min. Insulation Resistance (15.6°C) (MΩ·km)	Dielectric Strength (AC) (V/1min)	Allowable Current (reference) (A)	Unit Length (m) (ft)
	Size (AWG)	Construction (No./mm)	Diameter (mm)	Nominal Thickness (mm)	Diameter (mm)					
Stranded	30	7/0.102	0.31	0.28	0.87	354.00	30	500	1.5	610(2,000)
	28	7/0.127	0.38	0.28	0.94	223.00	30	500	2.0	610(2,000)
	26	7/0.160	0.48	0.28	1.04	139.00	30	500	3.0	610(2,000)
	24	7/0.203	0.61	0.28	1.17	85.90	30	500	4.0	610(2,000)
	22	7/0.254	0.76	0.28	1.32	54.70	30	500	6.0	610(2,000)
	20	7/0.320	0.96	0.28	1.52	34.40	30	500	9.0	610(2,000)
Solid	30	1/0.254	0.25	0.28	0.81	373.00	30	500	1.5	610(2,000)
	28	1/0.320	0.32	0.28	0.88	232.00	30	500	2.0	610(2,000)
	26	1/0.404	0.40	0.28	0.96	145.00	30	500	3.0	610(2,000)
	24	1/0.511	0.51	0.28	1.07	89.10	30	500	4.0	610(2,000)
	22	1/0.643	0.64	0.28	1.20	56.30	30	500	6.0	610(2,000)
	20	1/0.813	0.81	0.28	1.37	35.00	30	500	9.0	610(2,000)

- Remarks 1) Allowable current : Ambient temperature 40°C, Max. allowable temperature 105°C, single-wire in air
2) Conductor : Tin coated soft annealed copper wire

5-7 Fluoropolymer Wire

Fluoropolymer (ETFE) insulated wire

UL Style No.10086

- Rating UL : 600V, 200°C
- Standard UL : UL Subject 758

Application

Internal wiring of electrical and electronic equipments requiring heat and chemical resistance.

Features

1. Flame retardant : UL VW-1
2. Can be replaced by Silicon glass fiber braided wire (SF-2).
3. EU Directive RoHS : Restricted use of Pb, Cd, Hg, Cr+6, PBBs, PBDEs

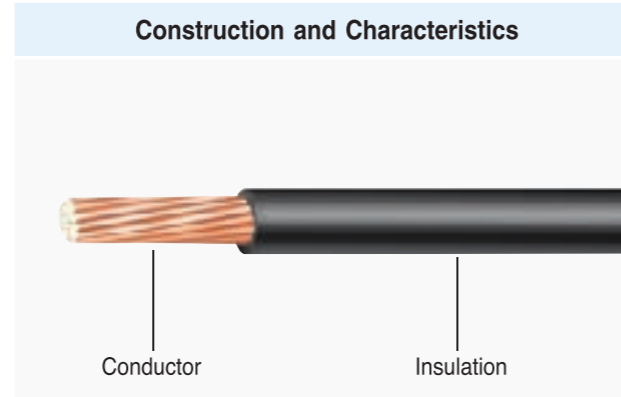

Marking

10086 E52853 VW-1  AWM 200C AWG NO. LS Cable

Type	Conductor			Insulation		Max. Cond. Resistance (20°C) (Ω/km)	Min. Insulation Resistance (15.6°C) (MΩ·km)	Dielectric Strength (AC) (V/1min)	Unit Length (m) (ft)
	Size (AWG)	Construction (No./mm)	Diameter (mm)	Nominal Thickness (mm)	Diameter (mm)				
Stranded	24	7/0.203	0.61	0.28	1.17	85.90	1,000	2,000	305(1,000)
	22	7/0.254	0.76	0.28	1.32	54.70	1,000	2,000	305(1,000)
	20	7/0.320	0.96	0.28	1.52	34.40	1,000	2,000	305(1,000)
	18	7/0.404	1.21	0.28	1.84	20.30	1,000	2,000	305(1,000)
	16	19/0.287	1.44	0.28	2.00	15.80	1,000	2,000	305(1,000)
	14	19/0.361	1.82	0.28	2.38	10.00	1,000	2,000	305(1,000)
Solid	24	1/0.511	0.51	0.28	1.07	89.10	1,000	2,000	305(1,000)
	22	1/0.643	0.64	0.28	1.20	56.30	1,000	2,000	305(1,000)
	20	1/0.813	0.81	0.28	1.37	35.00	1,000	2,000	305(1,000)

- Remarks
- 1) Size range : UL 36-4/0AWG
 - 2) Allowable current : Ambient temperature 40°C, Max. allowable temperature 200°C, single-wire in air
 - 3) TA : Tin coated soft annealed copper wire
GA : Silver coated soft annealed copper wire
NA : Nickel coated soft annealed copper wire
 - 4) TA : It can be used when diameter of strand is 0.381mm or larger

5-8 Fluoropolymer Wire

Fluoropolymer (ETFE) insulated wire

UL Style No.10109

- Rating UL : 300V, 200°C
- Standard UL : UL Subject 758

Application

Internal wiring of electrical and electronic equipments requiring heat and chemical resistance.

Features

1. Flame retardant : UL VW-1
2. EU Directive RoHS : Restricted use of Pb, Cd, Hg, Cr+6, PBBs, PBDEs

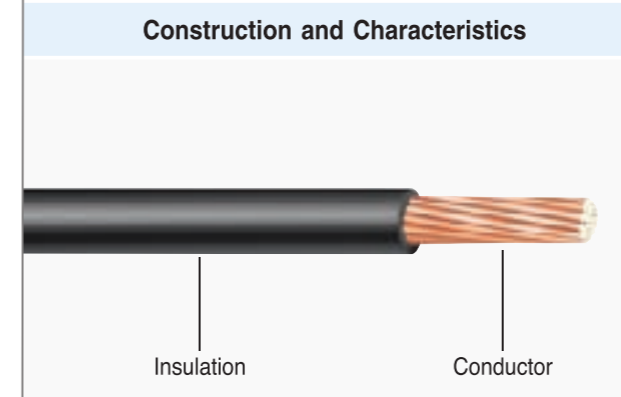

Marking

10109 E52853 VW-1  AWM 200C AWG NO. LS Cable

Type	Conductor			Insulation		Max. Cond. Resistance (20°C) (Ω/km)	Min. Insulation Resistance (15.6°C) (MΩ·km)	Dielectric Strength (AC) (V/1min)	Unit Length (m) (ft)
	Size (AWG)	Construction (No./mm)	Diameter (mm)	Nominal Thickness (mm)	Diameter (mm)				
Stranded	24	7/0.203	0.61	0.17	0.95	85.90	1,000	2,000	305(1,000)
	22	7/0.254	0.76	0.17	1.10	54.70	1,000	2,000	305(1,000)
	20	7/0.320	0.96	0.17	1.30	34.40	1,000	2,000	305(1,000)
	18	7/0.404	1.21	0.17	1.62	20.30	1,000	2,000	305(1,000)
	16	19/0.287	1.44	0.22	1.88	15.80	1,000	2,000	305(1,000)
	14	19/0.361	1.82	0.22	2.26	10.00	1,000	2,000	305(1,000)
Solid	24	1/0.511	0.51	0.17	0.85	89.10	1,000	2,000	305(1,000)
	22	1/0.643	0.64	0.17	0.98	56.30	1,000	2,000	305(1,000)
	20	1/0.813	0.81	0.17	1.15	35.00	1,000	2,000	305(1,000)

- Remarks
- 1) Size range : UL 36-4/0AWG
 - 2) Allowable current : Ambient temperature 40°C, Max. allowable temperature 200°C, single-wire in air
 - 3) TA : Tin coated soft annealed copper wire
GA : Silver coated soft annealed copper wire
NA : Nickel coated soft annealed copper wire
 - 4) TA : It can be used when diameter of strand is 0.381mm or larger

5-9 Fluoropolymer Wire

Fluoropolymer (FEP) insulated wire

UL Style No.1330

- Rating UL : 600V, 200°C
- Standard UL : UL Subject 758

Application

1. Internal wiring of electrical and electronic equipments requiring heat resistance.
2. Internal wiring of computer and business equipments requiring high transmission velocity.

Features

1. Flame retardant : UL VW-1
2. Excellent heat, cold, oil and chemical resistance.
3. Stable electric characteristics at high temperature and frequency and, small dielectric constant and dielectric loss.
4. EU Directive RoHS : Restricted use of Pb, Cd, Hg, Cr+6, PBBs, PBDEs

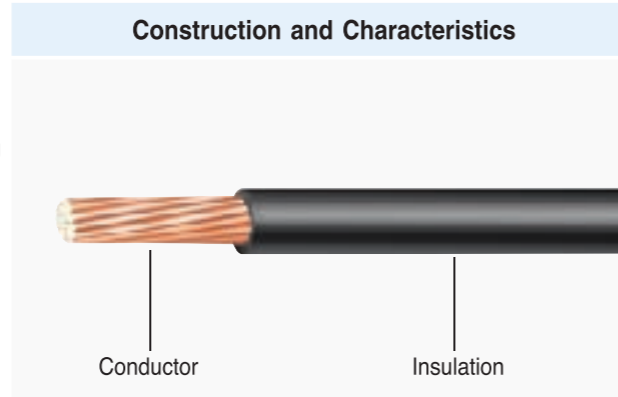

Marking

1330 E52853 VW-1  AWM 200C AWG NO. LS Cable

Type	Conductor			Insulation		Max. Cond. Resistance (20°C) (Ω /km)	Min. Insulation Resistance (15.6°C) (M Ω -km)	Dielectric Strength (AC) (V/1min)	Allowable Current (reference) (A)	Unit Length (m) (ft)
	Size (AWG)	Construction (No./mm)	Diameter (mm)	Nominal Thickness (mm)	Diameter (mm)					
Stranded	26	7/0.160	0.48	0.54	1.56	139.00	1,000	2,000	7.20	305(1,000)
	24	7/0.203	0.61	0.54	1.69	85.90	1,000	2,000	9.50	305(1,000)
	22	7/0.254	0.76	0.54	1.84	54.70	1,000	2,000	12.50	305(1,000)
	20	7/0.320	0.96	0.54	2.04	34.40	1,000	2,000	16.60	305(1,000)
	18	19/0.254	1.28	0.54	2.36	20.30	1,000	2,000	23.40	305(1,000)
	16	19/0.287	1.44	0.54	2.52	15.80	1,000	2,000	28.50	305(1,000)
	14	19/0.361	1.82	0.54	2.90	10.00	1,000	2,000	38.30	305(1,000)
Solid	26	1/0.404	0.40	0.54	1.48	145.00	1,000	2,000	7.20	305(1,000)
	24	1/0.511	0.51	0.54	1.59	89.10	1,000	2,000	9.50	305(1,000)
	22	1/0.643	0.64	0.54	1.72	56.30	1,000	2,000	12.50	305(1,000)
	20	1/0.813	0.81	0.54	1.89	35.00	1,000	2,000	16.60	305(1,000)
	1.4MM	1/1.4	1.40	0.57	2.54	12.10	1,000	2,000	28.50	305(1,000)
	1.2MM	1/1.2	1.20	0.57	2.34	15.90	1,000	2,000	23.40	305(1,000)
	1.0MM	1/1.0	1.00	0.57	2.14	23.80	1,000	2,000	16.60	305(1,000)

- Remarks 1) Allowable current : Ambient temperature 40°C, Max. allowable temperature 200°C, single-wire in air
 2) TA : Tin coated soft annealed copper wire
 GA : Silver coated soft annealed copper wire
 NA : Nickel coated soft annealed copper wire
 3) TA : It can be used when diameter of strand is 0.381mm or larger

5-10 Fluoropolymer Wire

Fluoropolymer (FEP) insulated wire

UL Style No.1331

- Rating UL : 600V, 150°C
- Standard UL : UL Subject 758

Application

1. Internal wiring of electrical and electronic equipments requiring heat resistance.
2. Internal wiring of computer and business equipments requiring high transmission velocity.

Features

1. Flame retardant : UL VW-1
2. Excellent heat, cold, oil and chemical resistance.
3. Stable electric characteristics at high temperature and frequency and, small dielectric constant and dielectric loss.
4. EU Directive RoHS : Restricted use of Pb, Cd, Hg, Cr+6, PBBs, PBDEs

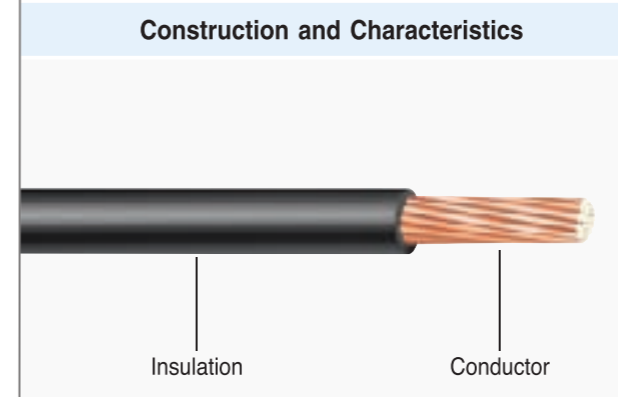

Marking

1331 E52853 VW-1  AWM 150C AWG NO. LS Cable

Type	Conductor			Insulation		Max. Cond. Resistance (20°C) (Ω /km)	Min. Insulation Resistance (15.6°C) (M Ω -km)	Dielectric Strength (AC) (V/1min)	Allowable Current (reference) (A)	Unit Length (m) (ft)
	Size (AWG)	Construction (No./mm)	Diameter (mm)	Nominal Thickness (mm)	Diameter (mm)					
Stranded	26	7/0.160	0.48	0.54	1.56	139.00	1,000	2,000	6.30	305(1,000)
	24	7/0.203	0.61	0.54	1.69	85.90	1,000	2,000	8.40	305(1,000)
	22	7/0.254	0.76	0.54	1.84	54.70	1,000	2,000	11.00	305(1,000)
	20	7/0.320	0.96	0.54	2.04	34.40	1,000	2,000	14.60	305(1,000)
	18	19/0.254	1.28	0.54	2.36	20.30	1,000	2,000	20.60	305(1,000)
	16	19/0.287	1.44	0.54	2.52	15.80	1,000	2,000	25.80	305(1,000)
	14	19/0.361	1.82	0.54	2.90	10.00	1,000	2,000	33.80	305(1,000)
Solid	26	1/0.404	0.40	0.54	1.48	145.00	1,000	2,000	6.30	305(1,000)
	24	1/0.511	0.51	0.54	1.59	89.10	1,000	2,000	8.40	305(1,000)
	22	1/0.643	0.64	0.54	1.72	56.30	1,000	2,000	11.00	305(1,000)
	20	1/0.813	0.81	0.54	1.89	35.00	1,000	2,000	14.60	305(1,000)

- Remarks 1) Allowable current : Ambient temperature 40°C, Max. allowable temperature 150°C, single-wire in air
 2) Conductor : Tin coated soft annealed copper wire

5-11 Fluoropolymer Wire

Fluoropolymer (FEP) insulated wire

UL Style No.1332 CSA Type AWM

- Rating UL : 300V, 200°C / CSA : 300V, 200°C
- Standard UL : UL Subject 758 / CSA : CSA C22.2 NO.210-2

Application

1. Internal wiring of electrical and electronic equipments requiring heat resistance.
2. Internal wiring of computer and business equipments requiring high transmission velocity.

Features

1. Flame retardant : UL VW-1
2. Excellent heat, cold, oil and chemical resistance.
3. Stable electric characteristics at high temperature and frequency and, small dielectric constant and dielectric loss.
4. Can be replaced by Silicon glass fiber braided wire(UL3122, SF-1).
5. EU Directive RoHS : Restricted use of Pb, Cd, Hg, Cr+6, PBBs, PBDEs

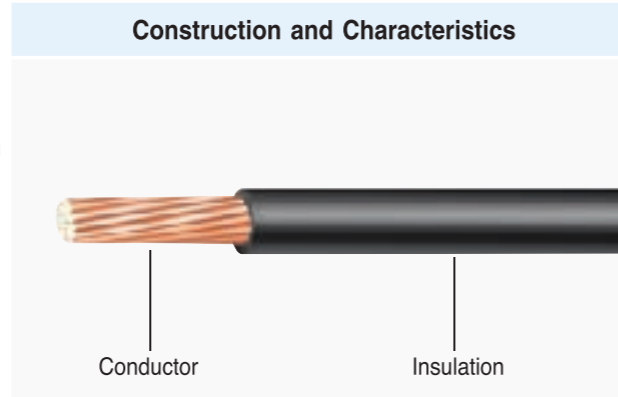

Marking

1332 E52853 VW-1 AWM 200C LL57184 CSA AWM I A/B 200C 300V FT1 AWG NO. LS Cable

Type	Conductor			Insulation		Max. Cond. Resistance (20°C) (Ω/km)	Min. Insulation Resistance (15.6°C) (MΩ·km)	Dielectric Strength (AC) (V/1min)	Allowable Current (reference) (A)	Unit Length (m) (ft)
	Size (AWG)	Construction (No./mm)	Diameter (mm)	Nominal Thickness (mm)	Diameter (mm)					
Stranded	28	7/0.127	0.38	0.35	1.08	223.00	1,000	2,000	239.00	610(2,000)
	26	7/0.160	0.48	0.35	1.18	139.00	1,000	2,000	150.00	610(2,000)
	24	7/0.203	0.61	0.35	1.31	85.90	1,000	2,000	94.20	610(2,000)
	22	7/0.254	0.76	0.35	1.46	54.70	1,000	2,000	59.40	610(2,000)
	20	7/0.320	0.96	0.35	1.66	34.40	1,000	2,000	36.70	610(2,000)
	18	19/0.254	1.28	0.35	1.98	20.30	1,000	2,000	23.20	610(2,000)
	16	19/0.287	1.44	0.35	2.14	21.40	1,000	2,000	14.60	610(2,000)
	14	19/0.361	1.82	0.35	2.52	15.80	1,000	2,000	8.96	610(2,000)
Solid	28	1/0.320	0.32	0.35	1.02	232.00	1,000	2,000	227.00	610(2,000)
	26	1/0.404	0.40	0.35	1.10	145.00	1,000	2,000	143.00	610(2,000)
	24	1/0.511	0.51	0.35	1.21	89.10	1,000	2,000	89.30	610(2,000)
	22	1/0.643	0.64	0.35	1.34	56.30	1,000	2,000	56.40	610(2,000)
	20	1/0.813	0.81	0.35	1.51	35.00	1,000	2,000	35.20	610(2,000)

- Remarks 1) Allowable current: Ambient temperature 40°C, Max. allowable temperature 200°C, single-wire in air
 2) TA : Tin coated soft annealed copper wire
 GA : Silver coated soft annealed copper wire
 NA : Nickel coated soft annealed copper wire
 3) TA : It can be used when diameter of strand is 0.381mm or larger

5-12 Fluoropolymer Wire

Fluoropolymer (FEP) insulated wire

UL Style No.1333 CSA Type AWM

- Rating UL : UL : 300V, 150°C / CSA : 300V, 150°C
- Standard UL : UL Subject 758 / CSA : CSA C22.2 NO.210-2

Application

1. Internal wiring of electrical and electronic equipments requiring heat resistance.
2. Internal wiring of computer and business equipments requiring high transmission velocity.

Features

1. Flame retardant : UL VW-1
2. Excellent heat, cold, oil and chemical resistance.
3. Stable electric characteristics at high temperature and frequency and, small dielectric constant and dielectric loss.
4. Can be replaced by Silicon glass fiber braided wire (UL3068, SFF-1).
5. EU Directive RoHS : Restricted use of Pb, Cd, Hg, Cr+6, PBBs, PBDEs

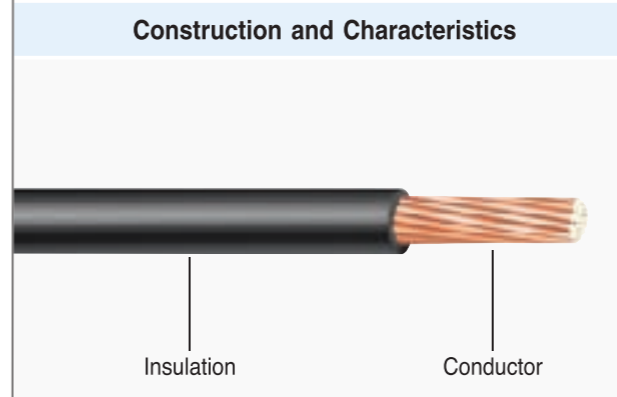

Marking

1333 E52853 VW-1 AWM 150C LL57184 CSA AWM I A/B 150C 300V FT1 AWG NO. LS Cable

Type	Conductor			Insulation		Max. Cond. Resistance (20°C) (Ω/km)	Min. Insulation Resistance (15.6°C) (MΩ·km)	Dielectric Strength (AC) (V/1min)	Allowable Current (reference) (A)	Unit Length (m) (ft)
	Size (AWG)	Construction (No./mm)	Diameter (mm)	Nominal Thickness (mm)	Diameter (mm)					
Stranded	28	7/0.127	0.38	0.35	1.08	223.00	1,000	2,000	4.20	305(1,000)
	26	7/0.160	0.48	0.35	1.18	139.00	1,000	2,000	5.60	305(1,000)
	24	7/0.203	0.61	0.35	1.31	85.90	1,000	2,000	7.50	305(1,000)
	22	7/0.254	0.76	0.35	1.46	54.70	1,000	2,000	10.00	305(1,000)
	20	7/0.320	0.96	0.35	1.66	34.40	1,000	2,000	13.40	305(1,000)
	18	19/0.254	1.28	0.35	1.98	20.30	1,000	2,000	19.30	305(1,000)
	16	19/0.287	1.44	0.35	2.14	15.80	1,000	2,000	23.70	305(1,000)
	14	19/0.361	1.82	0.35	2.52	10.00	1,000	2,000	32.20	305(1,000)
Solid	28	1/0.320	0.32	0.35	1.02	232.00	1,000	2,000	4.20	305(1,000)
	26	1/0.404	0.40	0.35	1.10	145.00	1,000	2,000	5.60	305(1,000)
	24	1/0.511	0.51	0.35	1.21	89.10	1,000	2,000	7.50	305(1,000)
	22	1/0.643	0.64	0.35	1.34	56.30	1,000	2,000	10.40	305(1,000)
	20	1/0.813	0.81	0.35	1.51	35.00	1,000	2,000	13.40	305(1,000)
	1.4SQ	55/0.180	1.54	0.35	2.24	14.20	1,000	2,000	32.20	305(1,000)
	1.25SQ	50/0.180	1.47	0.35	2.17	15.60	1,000	2,000	23.70	305(1,000)
	0.75SQ	30/0.180	1.14	0.35	1.84	26.00	1,000	2,000	13.40	305(1,000)
	0.5SQ	20/0.180	0.93	0.35	1.63	39.00	1,000	2,000	10.00	305(1,000)
	0.3SQ	12/0.180	0.72	0.35	1.42	65.00	1,000	2,000	7.50	305(1,000)

- Remarks 1) Allowable current : Ambient temperature 40°C, Max. allowable temperature 150°C, single-wire in air
 2) Conductor : Tin coated soft annealed copper wire

5-13 Fluoropolymer Wire

Fluoropolymer (PFA) insulated wire

UL Style No.1709

- Rating UL : 300V, 200°C
- Standard UL : UL Subject 758

Application

1. Suitable for electric and electronic equipments requiring heat resistance.
2. Internal wiring of computer and business equipments requiring high transmission velocity.

Features

1. Flame retardant : UL VW-1
2. Excellent heat, cold, oil and chemical resistance.
3. Stable electric characteristics at high temperature and frequency and, small dielectric constant and dielectric loss.
4. EU Directive RoHS : Restricted use of Pb, Cd, Hg, Cr+6, PBBs, PBDEs

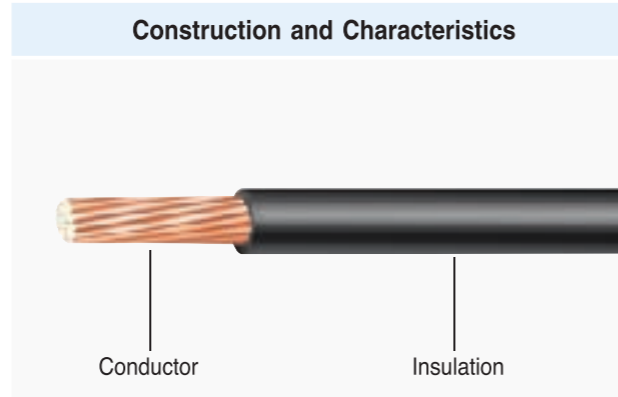

Type	Conductor			Insulation		Max. Cond. Resistance (20°C) (Ω/km)	Max. Cond. Resistance (20°C) (MΩ·km)	Dielectric Strength (AC) (V/1min)	Unit Length (m) (ft)
	Size (AWG)	Construction (No./mm)	Diameter (mm)	Nominal Thickness (mm)	Diameter (mm)				
Stranded	28	7/0.127	0.38	0.36	1.10	239.00	1,000	2,000	610(2,000)
	26	7/0.160	0.48	0.36	1.20	139.00	1,000	2,000	610(2,000)
	24	7/0.203	0.61	0.36	1.33	85.90	1,000	2,000	610(2,000)
	22	7/0.254	0.76	0.36	1.48	54.70	1,000	2,000	610(2,000)
	20	7/0.320	0.96	0.36	1.68	34.40	1,000	2,000	610(2,000)
	18	19/0.254	1.21	0.36	1.99	20.30	1,000	2,000	305(1,000)
	16	19/0.287	1.44	0.36	2.16	15.80	1,000	2,000	305(1,000)
	14	19/0.361	1.82	0.36	2.53	10.00	1,000	2,000	305(1,000)
Solid	28	1/0.320	0.32	0.36	1.04	232.00	1,000	2,000	610(2,000)
	26	1/0.404	0.40	0.36	1.12	145.00	1,000	2,000	610(2,000)
	24	1/0.511	0.51	0.36	1.23	89.10	1,000	2,000	610(2,000)
	22	1/0.643	0.64	0.36	1.36	56.30	1,000	2,000	610(2,000)
	20	1/0.813	0.81	0.36	1.53	35.00	1,000	2,000	610(2,000)

► Remarks 1) Conductor : Silver coated soft annealed copper wire, Nickel coated soft annealed copper wire

5-14 Fluoropolymer Wire

Fluoropolymer (PFA) insulated wire

UL Style No.1710

- Rating UL : 600V, 200°C
- Standard UL : UL Subject 758

Application

1. Suitable for electric and electronic equipments requiring heat resistance.
2. Internal wiring of computer and business equipments requiring high transmission velocity.

Features

1. Flame retardant : UL VW-1
2. Excellent heat, cold, oil and chemical resistance.
3. Stable electric characteristics at high temperature and frequency and, small dielectric constant and dielectric loss.
4. EU Directive RoHS : Restricted use of Pb, Cd, Hg, Cr+6, PBBs, PBDEs

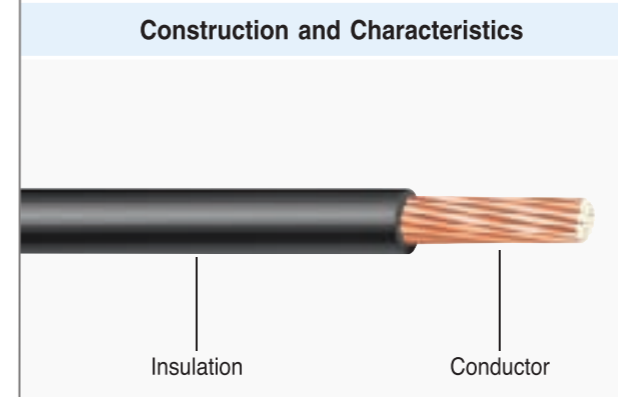

Type	Conductor			Insulation		Max. Cond. Resistance (20°C) (Ω/km)	Max. Cond. Resistance (20°C) (MΩ·km)	Dielectric Strength (AC) (V/1min)	Unit Length (m) (ft)
	Size (AWG)	Construction (No./mm)	Diameter (mm)	Nominal Thickness (mm)	Diameter (mm)				
Stranded	26	7/0.160	0.48	0.55	1.58	139.00	1,000	2,000	305(1,000)
	24	7/0.203	0.61	0.55	1.71	85.90	1,000	2,000	305(1,000)
	22	7/0.254	0.76	0.55	1.86	54.70	1,000	2,000	305(1,000)
	20	7/0.320	0.96	0.55	2.06	34.40	1,000	2,000	305(1,000)
	18	19/0.254	1.21	0.55	2.37	20.30	1,000	2,000	305(1,000)
	16	19/0.287	1.44	0.55	2.54	15.80	1,000	2,000	305(1,000)
	14	19/0.361	1.82	0.55	2.91	10.00	1,000	2,000	305(1,000)
	12	37/0.320	2.24	0.55	3.34	6.59	1,000	2,000	305(1,000)
Solid	26	1/0.404	0.40	0.55	1.50	145.00	1,000	2,000	305(1,000)
	24	1/0.511	0.51	0.55	1.61	89.10	1,000	2,000	305(1,000)
	22	1/0.643	0.64	0.55	1.74	56.30	1,000	2,000	305(1,000)
	20	1/0.813	0.81	0.55	1.91	35.00	1,000	2,000	305(1,000)

► Remarks 1) Conductor : Silver coated soft annealed copper wire, Nickel coated soft annealed copper wire

5-15 Fluoropolymer Wire

Fluoropolymer (PFA) insulated wire

UL Style No.1726

- Rating UL : 300V, 250°C
- Standard UL : UL Subject 758

Application

1. Suitable for electric and electronic equipments requiring heat resistance.
2. Internal wiring of computer and business equipments requiring high transmission velocity.

Features

1. Flame retardant : UL VW-1
2. Excellent heat, cold, oil and chemical resistance.
3. Stable electric characteristics at high temperature and frequency and, small dielectric constant and dielectric loss.
4. EU Directive RoHS : Restricted use of Pb, Cd, Hg, Cr+6, PBBs, PBDEs

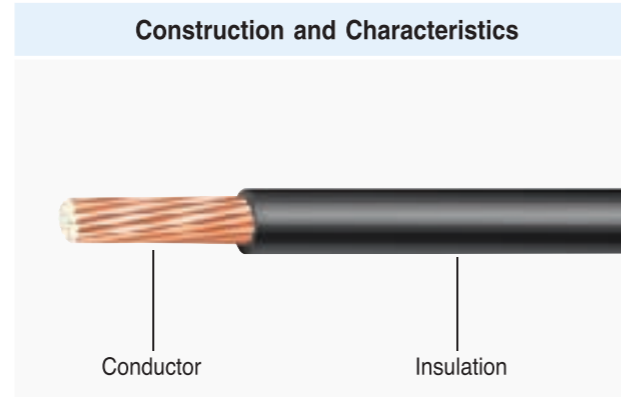

Marking

1726 E52853 VW-1  AWM 250C AWG NO. LS Cable

Type	Conductor			Insulation		Max. Cond. Resistance (20°C) (Ω/km)	Min. Insulation Resistance (15.6°C) (MΩ·km)	Dielectric Strength (AC) (V/1min)	Unit Length (m) (ft)
	Size (AWG)	Construction (No./mm)	Diameter (mm)	Nominal Thickness (mm)	Diameter (mm)				
Stranded	28	7/0.127	0.38	0.37	1.12	239.00	1,000	2,000	305(1,000)
	26	7/0.160	0.48	0.37	1.22	139.00	1,000	2,000	305(1,000)
	24	7/0.203	0.61	0.37	1.35	85.90	1,000	2,000	305(1,000)
	22	7/0.254	0.76	0.37	1.50	54.70	1,000	2,000	305(1,000)
	20	7/0.320	0.96	0.37	1.70	34.40	1,000	2,000	305(1,000)
	18	19/0.254	1.21	0.37	2.01	20.30	1,000	2,000	305(1,000)
	16	19/0.287	1.44	0.37	2.18	15.80	1,000	2,000	305(1,000)
	14	19/0.361	1.82	0.37	2.55	10.00	1,000	2,000	305(1,000)
Solid	28	1/0.320	0.32	0.37	1.06	232.00	1,000	2,000	305(1,000)
	26	1/0.404	0.40	0.37	1.14	145.00	1,000	2,000	305(1,000)
	24	1/0.511	0.51	0.37	1.25	89.10	1,000	2,000	305(1,000)
	22	1/0.643	0.64	0.37	1.38	56.30	1,000	2,000	305(1,000)
	20	1/0.813	0.81	0.37	1.55	35.00	1,000	2,000	305(1,000)

► Remarks 1) Conductor : Silver coated soft annealed copper wire, Nickel coated soft annealed copper wire

5-16 Fluoropolymer Wire

Fluoropolymer (PFA) insulated wire

UL Style No.1860

- Rating UL : 150V, 200°C
- Standard UL : UL Subject 758

Application

1. Suitable for electric and electronic equipments requiring heat resistance.
2. Internal wiring of computer and business equipments requiring high transmission velocity.

Features

1. Flame retardant : UL VW-1
2. Excellent heat, cold, oil and chemical resistance.
3. Stable electric characteristics at high temperature and frequency and, small dielectric constant and dielectric loss.
4. EU Directive RoHS : Restricted use of Pb, Cd, Hg, Cr+6, PBBs, PBDEs

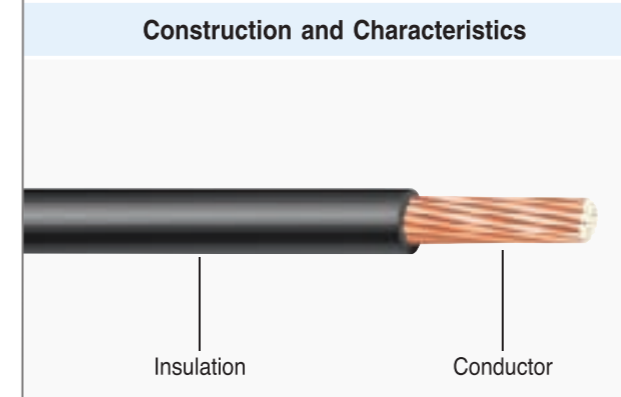

Type	Conductor			Insulation		Max. Cond. Resistance (20°C) (Ω/km)	Min. Insulation Resistance (15.6°C) (MΩ·km)	Dielectric Strength (AC) (V/1min)	Unit Length (m) (ft)
	Size (AWG)	Construction (No./mm)	Diameter (mm)	Nominal Thickness (mm)	Diameter (mm)				
Stranded	30	7/0.102	0.31	0.28	0.87	354.00	500	2,000	305(1,000)
	28	7/0.127	0.38	0.28	0.94	239.00	500	2,000	305(1,000)
	26	7/0.160	0.48	0.28	1.04	139.00	500	2,000	305(1,000)
	24	7/0.203	0.61	0.28	1.17	85.90	500	2,000	305(1,000)
	22	7/0.254	0.76	0.28	1.32	54.70	500	2,000	305(1,000)
	20	7/0.320	0.96	0.28	1.52	34.40	500	2,000	305(1,000)
	18	19/0.254	1.21	0.28	1.83	20.30	500	2,000	305(1,000)
	16	19/0.287	1.44	0.28	2.00	15.80	500	2,000	305(1,000)
Solid	30	1/0.254	0.25	0.28	0.81	373.00	500	2,000	305(1,000)
	28	1/0.320	0.32	0.28	0.88	232.00	500	2,000	305(1,000)
	26	1/0.404	0.40	0.28	0.96	145.00	500	2,000	305(1,000)
	24	1/0.511	0.51	0.28	1.07	89.10	500	2,000	305(1,000)
	22	1/0.643	0.64	0.28	1.20	56.30	500	2,000	305(1,000)
20	1/0.813	0.81	0.28	1.37	35.00	500	2,000	305(1,000)	

► Remarks 1) Conductor : Silver coated soft annealed copper wire, Nickel coated soft annealed copper wire

UL & CSA Standards

1. UL Standards

UL is an abbreviation for the Underwriters Laboratories Inc., a non-profit organization established in 1894 with the support of the National Board of Fire Underwriters, USA, for the purpose of public testing.

To protect human lives and property from fire and electric shock caused by defective products, burglary and other misfortunes, UL researches, tests, and inspects electric equipment, fire prevention products, gas products, petroleum products, chemical products, burglary-prevention products, and other products to provide an approval service. It also seeks to maintain the safety of product through a follow-up service.

Products earn the conformance certificate label issued from the UL head office when they have passed the UL list tests. This safety rating is highly valued in the USA. Accordingly, underwriters, agencies of the federal, state and municipal governments, manufacturers, contractors and others strongly demand UL list as a condition for acceptance or procurement.

All products to be shipped to the USA must obtain UL approval.

2. CSA Standards

CSA is an abbreviation for the Canadian Standard Association. It was established as a private non-profit agency in 1919 under the name of the Canadian Engineering Standards Association based on the Dominion Companies Act.

This name was replaced by the present short form in 1944 after expanding its standardization activities to a wide range of products. In addition to preparing standards this agency issues the CSA mark or the conformance certificate label to electric equipment and oil combustion units submitted for testing if the survey and test results show that the products conform to relevant laws, regulations, and CSA standards.

Law in Canada requires that all electric devices and Petroleum combustion units in domestic markets bear the CSA mark or the conformance certificate label.

UL & CSA Certificate Labels

1. Attachment of Labels to Products

LS Cable Ltd. attaches the labels to the rear of the exclusive tags of UL recognized and CSA certified wires.

Exclusive tags for both UL and CSA are attached to products recognized and certified by both institutions.

2. Handling of Labels

The UL and CSA conformance certificate labels are employed to certify that products conform to the respective approval agencies' testing. Pay particular attention to the following items.

- 1) Store the labels carefully until the electric units employing the wires have completed the UL or CSA witnessed tests.
- 2) LS Cable Ltd. will not issue the conformance certificate label again after products have been shipped.
- 3) These UL and CSA labels cannot be attached to other wires (products not conforming to UL or CSA standards).
- 4) The labels are shown in the illustrations on the right.

UL AWM

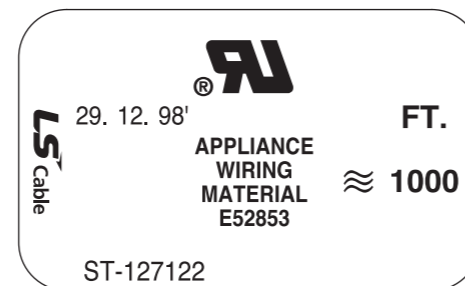

CSA

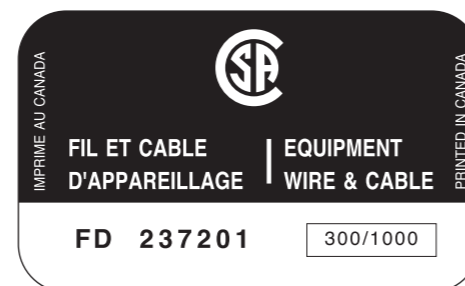

Marking of UL & CSA Approved Wires

The respective standards are indicated on UL recognized and CSA certified wires. However, they are not indicated on wires of small outer diameter, on which printing is difficult.

1. Marking

- 1) Product classification based on UL standards : AWM
- 2) UL style No.
- 3) Product classification based on CSA standards : Type No. and AWM (CSA certified product only)
- 4) Manufacturer's name : LS Cable
- 5) Rated temperature and rated voltage (AC) specified by UL and CSA standards.

(Note) If these indications are not required for certain products according to UL and CSA standards, they may be omitted.

- 6) Flammability : VW-1, VW-1SC, -F-
 - VW-1 : Indicated on products which have passed the Vertical Flammability Test and Horizontal Flammability Test specified by UL standards.
 - VW-1SC : Indicated on shielded wires or multi-conductor cable products where both finished products and insulated conductors have passed the Vertical Flammability Test and Horizontal Flammability Test specified by UL standards.
 - -F- : Indicated on products that have passed the Flammability Test required for internal wiring materials for TV receivers and are already registered with the Japan Electrical Appliance and Material Control Law (JEAMCL).
- 7) Conductor size : AWG size
- 8) Others

2. LS Cable's UL Recognized CSA Certified Number (File No.)

UL	
Type	File No.
Appliance Wiring Material (AWM)	E52853
Flexible Cord	E52854

CSA		
Type		File No.
Radio Circuit Wire	TR-64, TR-32	LL33908
Equipment Wire	TEW, REW	LL33911
Coil Lead Wire	CL1251, CL1252	LL57183
Appliance Wiring Material (AWM)		LL57183
Flexible Cord		LL33910

Definition of UL Style Numbers

Group	Style No.	Insulation Material	Core	Products
1	1001~1999	Thermoplastic (PVC, PE)	Single	Lead Wire / Teflon Wire / Coaxial Cable
2	2001~2999	Thermoplastic (PVC, PE)	Multiple	Computer Cable / Flat Cable / Cord, Feeder
3	3001~3999	Thermoset (XLPVC, XLPE)	Single	Irradiated Wire (XLPVC, XLPE)
4	4001~4999	Thermoset (XLPVC, XLPE)	Multiple	Irradiated Cable (XLPVC, XLPE)
5	5001~5999	Micellaneous (PVC, PE)	Micellaneous	Composite Wire & Cable (Fiber, PBT, PST)

Restrictions on the Use of UL & CSA Approved Wires

Wrong use and application of wires and cables not only shorten their lives but may also cause a serious accident. To prevent fires and electric shock, UL and CSA standards impose restrictions on the use of wires and cables based on NEC (National Electrical Code) or CEC (Canadian Electrical Code). The restrictions are specified on product tags.

1. Use Restrictions

- Restrictions on internal and external wiring, wires and cables are classified into three types as follows.
 - Those which can be employed for internal wiring of electronic equipments only.
 - Those which can be employed for external wiring of electronic equipments only.
 - Those which can be employed for both internal wiring and external wiring of electronic equipments. If it is difficult to distinguish between the internal and external wiring, it is recommended to use a wire for both internal wiring and external wiring.

2) Peak voltage limits

The peak voltages allowed for wires and cables of rated voltage other than 30V are specified in the following table based on UL and CSA standards. When these peak voltage are applied, the cautions required for the wiring of each UL electronic device must be observed.

Peak voltages for various rated voltages

Rated voltage (VAC)	Peak voltage	
	UL standard	CSA standard
125 & 150	300	-
300	600	600
600	2,500	1,400

2. Circuit Restrictions

- Fire hazard

A fire hazard exists if the open voltage of a circuit which feeds more than 15 watts of power to an external resistance exceeds:

 - 42.4V peak when the circuit is in danger of touching an indoor unit or water.
 - 21.2V peak when the circuit may touch an outdoor unit or water.
- Electric shock hazard

Electric shock hazard exists when the open voltage between an exposed part and the ground or other easily touchable part is as specified below.

 - 42.4V peak for an indoor unit with no possibility of touching water.
 - 21.2V peak when there is the possibility of touching an outdoor unit or water. And electric shock hazard also exists where the current continuously flowing through a 500Ω resistor exceeds values specified in the following table.

Maximum allowable current (electric shock)

Frequency (Hz)	Maximum allowable current (mA) flowing through a 500Ω resistor
0 - 100	7.1
500	9.4
1,000	11.0
2,000	14.1
3,000	17.3
4,000	19.6
5,000	22.0
6,000	25.1
Higher than 7,000	27.5

Registration in Accordance with JQA Equipment Inflammability (-F- Mark)

1. Registration

Internal wiring materials for TV receivers and portable TV cameras cannot be used unless they conform to the Japan Electrical Appliance and Material Control Law. Each manufacturer registers the electrical products by requesting JMI to conduct the inflammability test.

2. LS Cable's Product Types for Inflammability Registration.

Type	Style No.	Size (AWG)	Registration No.
Heat-resistant vinyl wire	UL1007	All Size	GSC 1-001
	UL1061		GSC 1-001
	UL1275		GSC 1-003
	UL1015		GSC 1-002
	UL1032		GSC 1-002
	UL1283		GSC 1-003
Flat cable	UL2877	20AWG or less	GSC 1-015, 016
	UL2878		GSC 1-015, 016
	UL2468		GSC 1-015, 016
	UL2651		GSC 1-015, 016
	UL3239		GSC 1-005, 007
Irradiation cross-link polyethylene wire	UL1429	All Size	GSC 1-001
	UL1430		GSC 1-001
	UL1571		GSC 1-001
High voltage wire	UL1672	All Size	GSC 1-001
	UL1618	20-26AWG	GSC 1-001
	UL1617	26AWG or more	GSC 1-002

Type	Style No.	Size (AWG)	Registration No.
Heat-resistant vinyl shielded wire	UL1185	All Size	GSC 1-014
	UL1533	20AWG or less	GSC 1-014
	UL2405	26AWG or less	GSC 1-017
	UL2547	20AWG or less	GSC 1-017
Irradiation cross-link polyethylene wire	UL3265	All Size	GSC 1-005
	UL3266	All Size	GSC 1-005
	UL3271	26AWG or less	GSC 1-007
	UL3273	26AWG or less	GSC 1-007
Irradiation polyethylene insulated shielded wire	UL3321	26AWG or less	GSC 1-007
	UL1691	20AWG or less	GSC 1-004
UL2791	GSC 1-010		
Polyethylene insulated coaxial cable	UL1365	All Size	GSC 1-006, 008
	UL1354		GSC 1-006, 008

Construction of Stranded Conductors

1. Types of Conductors

- Solid Wires
- Concentric Stranded Wire
- Bunched Stranded Wire : Flexible
- Rope Lay Stranded Wire : Bunched Stranded Wires cabled into single construction.

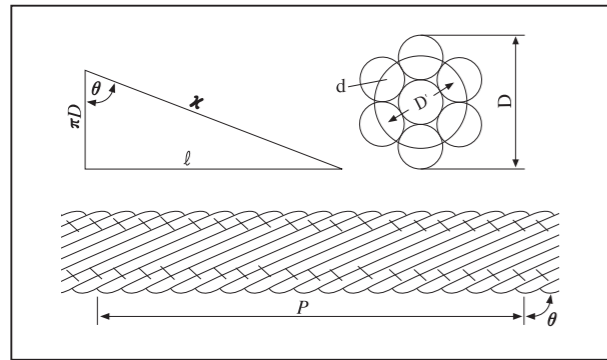

2. Pitch and Stranding Ratio of Stranded Wire

Assume the following symbols for a circular stranded wire :

- d : Wire Diameter
- D' : Pitch Diameter (circle is referred to as the pitch circle)
- D : Outer diameter of stranded wire
- P : Lay-axial length of wire required for one strand to complete one revolution.
- x : Axial length of strand required to complete one revolution

Stranding Ratio

$$= \frac{x}{P} - 1 = \sqrt{\left(\frac{\pi D'}{P}\right)^2 + 1} - 1 = \frac{1}{2} \left(\frac{\pi D'}{P}\right)^2 - \frac{1}{8} \left(\frac{\pi D'}{P}\right)^4 + \dots$$

Gradient angle of Strand : $\theta = \sin^{-1}\left(\frac{P}{x}\right)$

3. Standard Conductor Chart

AWG Size

Size (AWG)	Solid Wire	Concentric Stranding	Bunched Stranding / Rope Lay Stranding	Rope Lay Stranding
36	1/0.127	7/0.05	7/0.05	-
32	1/0.203	7/0.08	7/0.08	-
30	1/0.26	7/0.102	7/0.102	-
28	1/0.32	7/0.127	7/0.127	3/16/0.05
26	1/0.404	7/0.16	7/0.16	3/23/0.05
24	1/0.511	7/0.203	11/0.16	7/16/0.05
22	1/0.644	7/0.26	17/0.16	7/25/0.05
20	1/0.813	7/0.32	26/0.16	7/38/0.05
18	1/1.024	19/0.26	43/0.16	7/61/0.05
16	1/1.29	19/0.287	54/0.18	7/96/0.05
14	1/1.628	19/0.361	41/0.26	-
12	1/2.052	37/0.32	65/0.26	-
10	1/2.588	37/0.404	104/0.26	-
8	-	-	7/24/0.26	-
6	-	-	7/28/0.26	-
4	-	-	7/60/0.26	-
2	-	-	19/35/0.26	-
1	-	-	19/44/0.26	-
1/0	-	-	19/55/0.26	-
2/0	-	-	19/70/0.26	-
3/0	-	-	19/88/0.26	-
4/0	-	-	37/57/0.26	-

(No./mm, No./No./mm)

KS / JIS Size

Size (mm ²)	Concentric Stranding	Bunched Stranding / Rope Lay Stranding
0.035	7/0.08	7/0.08
0.05	7/0.1	7/0.1
0.1	7/0.14	7/0.14
0.14	7/0.16	7/0.16
0.18	7/0.18	7/0.18
0.2	7/0.2	7/0.2
0.3	7/0.26	12/0.18
0.5	7/0.32	19/0.18
0.75	-	30/0.18
1.25	7/0.45	50/0.18
2	7/0.6	37/0.26
3.5	7/0.8	45/0.32
5.5	7/1.0	35/0.45
8	7/1.2	50/0.45
14	7/1.6	88/0.45
22	7/2.0	7/20/0.45
38	7/2.6	7/34/0.45
60	19/2.0	19/20/0.45
100	19/2.6	19/34/0.45

(No./mm, No./No./mm)

General Characteristics of Insulation Materials

Material	PVC Resin			Polyethylene		Polypropylene	Fluorine Resin					Flame Resistant Polyflex	Polyamide Nylon		
	PVC	Heat Resistant PVC	Cross-linked PVC	Polyethylene	Cross-linked Polyethylene		Vinylidene Fluoride	Ethylene-tetrafluorethylene	Fluorethylene Propylene	Polytetrafluorethylene	Perfluoroalcoxy			Fluonlex	
Symbol	PVC	H-PVC	XL PVC	PE	XLPE	PP	PVdF	ETFE	FEP	PTFE	PFA	LEF	-	NY	
Electrical	Dielectric Strength (kV/mm)	20~35	20~35	25~40	35~50	35~50	20~35	20~35	15~30	20~30	20~35	20~30	20~39	-	
	Volume Resistivity (Ω/cm)	10 ¹² ~10 ¹⁵	10 ¹² ~10 ¹⁵	10 ¹⁸	10 ¹⁸	10 ¹⁸	10 ¹⁴	>10 ¹⁶	>10 ¹⁸	>10 ¹⁸	>10 ¹⁸	10 ¹⁵	10 ¹⁴	-	
	Dielectric Constant	6~8	6~8	3.5~5	2.3	2.3	2.3	3.5~8	2.6	2.1	2.1	2.1	3.8	5~6	-
	Dielectric Power Factor (%)	4~12	4~12	3~10	0.02~0.05	0.02~0.05	0.02~0.05	5~25	0.2	0.03	0.02	0.02	-	2~3	-
Mechanical	Tensile Strength (kg/mm ²)	1.0~2.5	1.0~2.5	1.5~3.0	1.2~1.5	1.2~1.5	2.5~3.5	7~8	6~7	6~7	1.5~3.0	1.5~3.0	1.6	1.5~2.0	4~7
	Elongation (%)	100~400	100~400	100~300	500~700	200~500	500~700	350~450	200~300	100~300	100~300	100~300	350	500~600	100~300
Specific Gravity	1.25~1.40	1.25~1.40	1.25~1.40	0.92~0.95	0.92~0.95	0.89~0.90	1.77	1.7	2.2	2.2	2.2	1.7	1.2~1.3	1.1~1.5	
Softening Temperature (°C)	120	150	-	105~115	-	160	149	270	285	327	305	-	-	230	
Rated Temperature (°C)	60	75~105	105	75	105~125	105	105	150	200	250	250	200	105	90	
Flame Retardant	Very Good	Very Good	Very Good	Unsatisfactory	Unsatisfactory	Unsatisfactory	Excellent	Excellent	Excellent	Excellent	Excellent	Excellent	Excellent	Unsatisfactory	
Heat Resistance	Aging Resistance	Fair	Good	Very Good	Good	Very Good	Very Good	Excellent	Excellent	Excellent	Excellent	Excellent	Excellent	Very Good	Very Good
	Heat Deformation Resistance	Fair	Fair	Excellent	Fair	Excellent	Good	Excellent	Excellent	Excellent	Excellent	Excellent	Good	Very Good	Very Good
Cold Resistance	Fair	Fair	Fair	Very Good	Very Good	Fair	Excellent	Excellent	Excellent	Excellent	Excellent	Excellent	Excellent	Fair	
Weather Resistance	Excellent	Excellent	Excellent	Unsatisfactory (Excellent)	Unsatisfactory (Excellent)	Unsatisfactory (Excellent)	Excellent	Excellent	Excellent	Excellent	Excellent	Excellent	Excellent	Good	
Ozone Resistance	Excellent	Excellent	Excellent	Excellent	Excellent	Excellent	Excellent	Excellent	Excellent	Excellent	Excellent	Excellent	Excellent	Very Good	
Oil Resistance	Good	Good	Good	Good	Excellent	Excellent	Excellent	Highly Excellent	Highly Excellent	Highly Excellent	Highly Excellent	Highly Excellent	Excellent	Good	Very Good
Acid Resistance	Excellent	Excellent	Excellent	Excellent	Excellent	Good	Excellent	Excellent	Highly Excellent	Highly Excellent	Excellent	Excellent	Excellent	Fair	
Alkali Resistance	Excellent	Excellent	Excellent	Excellent	Excellent	Excellent	Excellent	Excellent	Highly Excellent	Highly Excellent	Excellent	Excellent	Excellent	Good	

General Characteristics of Insulation Materials

Symbol	Material	Polychlorosulfonated Polyethylene (Hypalon)	Silicone Rubber	Polychloroprene	Ethylene Propylene Polymer
Characteristics		CSPE	SIR	CR	EPR
Chemical Composition		Polychlorosulfonated Polyethylene	Dimethyl Siloxane Polymer	Polychloroprene Polymer	Ethylene Propylene Polymer
Uses		Insulation, Sheath	Insulation	Sheath	Insulation
Electrical Characteristics	Dielectric Strength (kV/mm)	20~30	20~30	15~25	37~48
	Volume Resistivity (Ω/cm)	10^{10-14}	10^{14-15}	10^{7-12}	10^{16}
	Dielectric Power Factor	4~5	3~4	7~10	3
	Dielectric Constant (%)	3 or less	3 or less	15 or less	15 or less
Mechanical Characteristics	Tensile Strength (kg/mm ²)	0.4~0.8	0.4~1.0	~2.0	0.9
	Elongation (%)	200~400	100~300	300~1,000	1,000
	Wear Resistance	Excellent	Fair	Excellent	Good
Specific Gravity (Raw Rubber)		1.10	1.7	1.15~1.23	0.86
Rated Temperature (°C)		90	180	75	90
Flame Resistance		Good	Fair	Excellent	Unsatisfactory
Heat Resistance		Excellent	Highly Excellent	Good	Very Good
Cold Resistance		Good	Excellent	Fair	Excellent
Weather Resistance		Excellent	Excellent	Excellent	Excellent
Ozone Resistance		Highly Excellent	Highly Excellent	Good	Highly Excellent
Oil Resistance		Good	Fair	Good	Unsatisfactory
Water Resistance		Good	Fair	Fair	Good

Oil and Solvent Resistance of Plastic and Rubber Materials

Material	PVC Resin (Soft for wire)	Polyethylene	Cross-linked Polyethylene	Fluorine Resin	Fluorine Rubber	Silicone Rubber	S B R	Nitrile Rubber	Butyl Rubber	Chloroprene Rubber	Natural Rubber	Hypalon	Polyflex	Ethylene Propylene Rubber
Dipping Chemicals														
Benzene	B	B	B	A	C	F	E	E	E	E	E	E	E	D
Hexane	C	B	B	A	A	E	E	A	E	C	E	C	D	D
Naphtha	B	B	B	A	C	E	E	D	F	E	E	F	D	B
Gasoline	C	B	B	A	B	E	E	A	F	C	E	D	D	B
Chloroform	D	B	B	A	D	E	F	G	F	F	F	G	E	D
Carbon Tetrachloride	A	B	B	A	C	F	F	C	F	F	F	G	E	B
Carbon Disulfide	B	B	B	A	B	D	F	B	E	F	F	F	D	E
Acetone	D	A	A	A	C	C	A	F	A	A	A	A	B	A
Ethylene Glycol	A	A	A	A	A	A	A	A	B	A	A	A	A	A
Glycerine	A	A	A	A	A	A	A	A	A	A	A	A	A	A
Ethyl Alcohol	A	A	A	A	A	A	A	A	A	A	A	A	A	A
Furfural	C	A	A	A	C	B	A	F	A	A	A	A	A	B
Cresol	B	A	A	A	A	A	B	F	B	C	B	C	D	B
Creosote Oil	F	B	B	A	C	A	F	G	B	F	F	G	C	D
Aniline	B	B	B	A	A	A	B	G	A	D	B	B	C	B
ASTM No.1 Oil	A	A	A	A	A	A	B	A	A	A	C	A	A	D
ASTM No.2 Oil	A	A	A	A	A	A	B	A	B	A	C	A	B	D
ASTM No.3 Oil	A	A	A	A	A	B	E	A	D	B	F	B	C	E
Transformer Oil	A	A	A	A	A	B	F	A	F	B	F	C	C	D
Silicone Oil	A	A	A	A	A	C	A	A	A	A	A	A	A	A
Vegetable Oil	A	A	A	A	A	A	B	A	A	A	C	A	A	A
D O P	B	A	A	A	B	A	C	A	A	E	C	D	B	D
Petroleum Ether	E	A	A	A	F	F	E	C	C	D	E	C	C	B
Freon 12	A	A	A	A	D	E	E	C	E	E	F	D	B	B
Heavy Oil	A	B	B	A	A	D	E	A	F	C	E	D	C	E
Trichlene	B	B	B	A	C	E	F	D	F	E	F	E	E	B

Remarks

1. A : Virtually no change
 B : Affected slightly
 C : Slight swelling, but no major affect
 D : Noticeable swelling. Not suitable for practical purposes except in special cases
 E : Swollen. Not suitable for practical uses
 F : Seriously swollen
 G : Maximum swelling and decomposition
2. Results will depend upon the temperature. Use this table as a general guide.

Migration of Plastic and Rubber Materials

Insulation Material Contact Material	Name	PVC (Including Cross-linked PVC)	Polyethylene (Including Cross-linked Polyethylene)	Vinylidene Fluoride	TFE FEP	ETFE	Nylon	Chloroprene Rubber	Butyl Rubber	Polyester
Thermosetting Substances	Phenol	PF	○	○	○	○	○	○	○	○
	Urea	UF	○	○	○	○	○	○	○	○
	Melamine	MF	×	○	○	○	○	○	×	○
	Epoxy	EP	○	×	○	○	○	○	○	○
	Unsaturated Polyester	UP	○	○	○	○	○	○	○	○
	Diarylpthalate	PDAP	○	○	○	○	○	○	○	○
	Polybutylene Terephthalate	PBT	○	○	○	○	○	○	○	○
	Alkyd		○	○	○	○	○	○	○	○
	Noryl (denatured PPO)	PPO	○	○	○	○	○	○	○	○
	Silicone	SI	×	○	○	○	○	○	○	○
Thermoplastic Substances	PVC	PVC	○	×	○	○	○	×	×	○
	Vinylidene Fluoride	PVdF	○	○	○	○	○	×	×	○
	Styrene Sterol	PS	×	○	○	○	○	○	×	○
	ABS	ABS	×	○	○	○	○	○	×	○
	ABC	ABC	×	○	○	○	○	○	○	○
	Polyethylene	PE	×	○	○	○	○	×	×	○
	Polypropylene	PP	○	○	○	○	○	○	×	○
	Nylon Polyamide	PA	○	○	○	○	○	○	○	○
	Polyacetal	POM	○	○	○	○	○	○	○	○
	Polymethyl Methacrylate	PMMA	×	○	○	○	○	○	×	○
	TFE/PTFE	TFE	○	○	○	○	○	○	○	○
	FEP	FEP	○	○	○	○	○	○	○	○
	CTEF/Kel-F	CTFE	○	○	○	○	○	○	○	○
	Tefzel	ETFE	○	○	○	○	○	○	○	○
	Polycarbonate	PC	×	○	○	○	○	○	○	○
	Polyether		○	○	○	○	○	○	○	○
	Ionomer		○	○	○	○	○	○	○	○
	Acetate	CA	×	○	○	○	○	×	×	○
	Polyurethane	PUR	○	○	○	○	○	○	×	○
	Natural Rubber	NR	×	○	×	○	○	○	○	○
Butyl Rubber	IIR	×	×	×	○	○	○	○	○	
Silicone Rubber	SiR	×	○	×	○	○	○	○	○	
Neoprene Rubber	CR	×	○	×	○	○	○	○	○	
Nitrile Rubber	NBR	×	○	×	○	○	○	○	○	
SBR Rubber	SBR	×	○	×	○	○	○	○	○	
AS	AS	×	○	○	○	○	○	○	○	

Remarks

○ : No Migration / × : Migration

Migration does not always move away from the wire. It can also move towards the wire.

Shield Effect of Various Shielded Wires for Electronic Appliances

Various signal circuits and high frequency circuits for home electrical appliances use shielded wires for electrostatic shielding. These wires use electrolytic copper, aluminum foil, conductive plastic and other materials as the shielding layers. The shielding effect of these materials can be evaluated by the following testing method.

1. Shielding Effect Evaluation Method

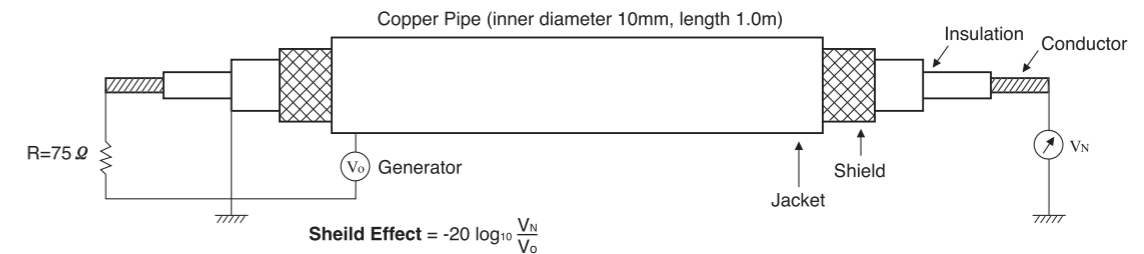

2. Wires Measured for Shield Effect

Type of Wire	Type of Shield	Construction
2.5C-2V 1/0.4 φ /	Braided (electrolytic copper)	Conductor Insulation (PE) Braided Shield Jacket (PVC)
UL1691 -SW 1X24AWG	Wrapped (electrolytic copper)	Drain Wire Jacket (PVC) Conductor Insulation (M-IREF)* Wrapped Shield
UL1691 -SX(AL) 1X24AWG	Aluminum Foil	Drain Wire Jacket (PVC) Conductor Insulation (M-IREF)* Aluminum Foil Shield
UL1691 -SX(PL) 1X24AWG	Conductive PVC	Drain Wire Jacket (PVC) Conductor Insulation (M-IREF)* Conductive PVC Shield

Flame-resistant irradiated cross-linked cellular polyethylene

3. Shield Effect

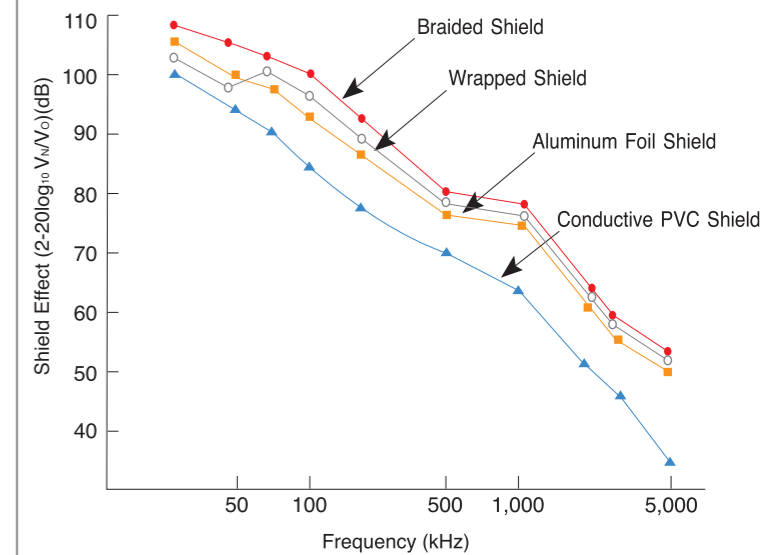

Electrical Characteristics Calculation Formulations

1. DC Conductor Resistance

$$R = \rho \frac{l}{S} = \rho \frac{4l}{\pi d^2} (\Omega) \quad R_t = R \{1 + \alpha(t-20)\} (\Omega)$$

- ρ : Volume resistivity of conductor (Ω /mm)
- R : DC Conductor Resistance at 20°C (Ω)
- R_t : DC Conductor Resistance at t°C (Ω)
- l = Conductor Length (cm)
- d = Conductor Diameter (cm)
- S = Cross-sectional Area of Conductor (cm^2)
- α = Temperature Coefficient
(annealed copper wire : 0.00393)
- σ = Conductivity (%)

Cross-sectional area of stranded annealed copper wire 1mm².
Resistance in case of 1m in length is obtained by:

$$R = \frac{1}{58} = 0.017241$$

1) DC Resistance of Single Annealed Copper Wire is

$$R = \frac{4 \times 10^3}{58 \pi d^2} (\Omega/\text{km})$$

2) DC Resistance of Stranded Annealed Copper Wire is

$$R = \frac{4 \times 10^3}{58 \cdot \pi \sigma d^2 \cdot n} (1+S) (\Omega/\text{km})$$

Where n : number of wire strands

S : Stranding Ratio - 2% for less than 60 strands
- 3% for more than 60 strands

3) Conductivity (σ) of Annealed Copper Wire

Size	Annealed Copper Wire	Tinned Annealed Copper Wire
0.08~0.29	0.98	0.93
0.291~0.45	0.993	0.94
0.50~2.40	1.00	0.96

2. Insulation Resistance

$$R = \frac{3.665}{l} \cdot \rho \cdot \log_{10} \frac{D}{d} \times 10^6 (M\Omega)$$

- R : Insulation Resistance (M Ω)
- ρ : Volume Resistivity of Insulator (Ω /cm)
- d : Outer Diameter of Conductor (mm)
- D : Outer Diameter of Insulation (mm)
- l : Wire Length (cm)

3. Capacitance

1) Coaxial Cable

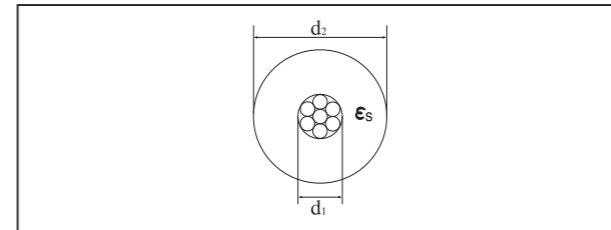

- C : Capacitance (nF/km)
- d_o : Wire diameter of inner conductor (mm)
- d_{oo} : Inner diameter of outer conductor (mm)
- d_w : Braided wire diameter (mm)
- ϵ_s : Effective dielectric constant
- d_1 : Equivalent outer diameter of inner conductor (mm)
- $\epsilon = d_o \times k \times k$
(k : Multiplier of stranded wire outer diameter,
k : Equivalent outer diameter coefficient)
- d_2 : Outer conductor equivalent inner diameter = $d_{oo} + 1.5d_w$

Number of Stranded Conductors	k	k
1	1.0	1.0
7	0.94	3.0
12	0.96	4.15
19	0.97	5.0

$$C = \frac{10^3 \epsilon}{18 \ln \frac{d_2}{d_1}} = \frac{24.12 \epsilon}{\log_{10} \frac{d_2}{d_1}} (\text{nF/km})$$

2) Twisted Pair Wires

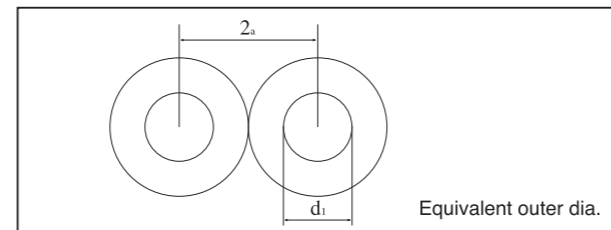

- $2a$: Distance between conductor centers (mm)
- ϵ_s : Specific Dielectric Constant of Insulation
- $C = \frac{\pi \epsilon}{\ln \frac{2a + \sqrt{(2a)^2 - (d_1)^2}}{d_1}} = \frac{12.08 \epsilon_s}{\log_{10} \frac{2a + \sqrt{(2a)^2 - (kd_1)^2}}{d_1}} (F/m)$

Electrical Characteristics Calculation Formulations

3) Shielded pair (Multipair cable)

$$C \approx \frac{27.8 \epsilon}{\ln \frac{0.94D}{d_1}} (\text{nF/km})$$

- ϵ : Effective dielectric constants
- D : Outer diameter of a pair

4. Cable Constant Calculation Formulas (Sine Wave AC)

- Symbols :
- R : Return Resistance (Ω /loop.km)
- L : Inductance (H/km)
- C : Capacitance (F/km)
- G : Conductance (Ω /km)
- f : Frequency (Hz)
- ω : Angular Frequency (= $2\pi f$)
- α : Attenuation (Np/km)(INp = 8.686dB)
- β : Phase (rad/km)
- γ : Propagation Constant $\gamma = \alpha + j\beta$
- Z_o : Characteristic Impedance (Ω)

1) Basic Secondary Constant Formulas

- Propagation Constant
 $\gamma = \sqrt{(R+j\omega L)(G+j\omega C)} = \alpha + j\beta$
- Characteristic Impedance
 $\alpha = \sqrt{\frac{1}{2} \{ \sqrt{(R^2 + \omega^2 L^2)(G^2 + \omega^2 C^2)} + (RG - \omega^2 LC) \}}$
- Attenuation Phase
 $\beta = \sqrt{\frac{1}{2} \{ \sqrt{(R^2 + \omega^2 L^2)(G^2 + \omega^2 C^2)} - (RG - \omega^2 LC) \}}$
- Characteristic Impedance
 $Z_o = \sqrt{\frac{R+j\omega L}{G+j\omega C}} = |Z_o| e^{j\theta} (\theta: \text{rad})$

2) Secondary Constant Approximation Formulas

- For DC, since $\omega = 0$:
 $\alpha = \sqrt{RG} \quad \beta = 0 \quad |Z_o| = \sqrt{\frac{R}{G}}$
- For very low frequencies (at the most up to commercial frequencies) since ($\omega \approx 0, \omega L \ll R, \omega C \ll G$).
 $\alpha \approx \sqrt{RG} \quad \beta \approx \omega \left(\frac{L}{2\sqrt{R}} + \frac{C}{2\sqrt{G}} \right) \quad |Z_o| \approx \sqrt{\frac{R}{G}} \quad \theta \approx \frac{1}{2} \left(\frac{\omega L}{R} - \frac{\omega C}{G} \right)$
- For low frequencies (audio frequencies) since ($\omega L \ll R, \omega C \gg G, LG \ll RC$).
 $\alpha \approx \beta \approx \sqrt{\frac{\omega CR}{2}} \quad |Z_o| = \sqrt{\frac{R}{j\omega C}} = \sqrt{\frac{R}{2\omega C}} - j\sqrt{\frac{R}{2\omega C}}$

- For high frequencies (higher than about several tens of kHz) since ($\omega L \gg R, \omega C \gg G$).

$$\alpha \approx \left(\frac{R}{2\sqrt{L}} + \frac{G}{2\sqrt{C}} \right) \quad \beta \approx \omega \sqrt{LC}$$

(ii) Characteristic Impedance

$$Z_o \approx \sqrt{\frac{L}{C}}$$

5. Coaxial Cable Constant Calculation Formulas

- Symbols :
- d_1 : Equivalent outer diameter of inner conductor (m)
- d_2 : Equivalent inner diameter of outer conductor (m)
- t_1 : Thickness of inner conductor (m)
- t_2 : Thickness of outer conductor (m)
- ϵ : Effective dielectric constant of insulation ($\epsilon_s \epsilon_0$)
- ϵ_s : Effective specified dielectric constant of insulation
- ϵ_0 : Dielectric constant in vacuum
- μ : Effective permeability of insulation
- μ_0 : Permeability in vacuum
- μ_1 : Permeability of inner conductor (H/m)
- μ_2 : Permeability of outer conductor (H/m)
- ρ_0 : Resistivity of stranded annealed copper
- ρ_1 : Resistivity of inner conductor (m)
- ρ_2 : Resistivity of outer conductor (m)
- $\tan \delta$: Effective insulator dielectric power factor
- R : Effective conductor resistance (Ω /m)
- R_1 : Effective resistance of inner conductor (outer surface resistance)(Ω /m)
- R_2 : Effective resistance of outer conductor (outer surface resistance)(Ω /m)
- L : Inductance (H/m)
- L_1 : Self Inductance of inner conductor (outer surface inductance)(H/m)
- L_2 : Self Inductance of outer conductor (inner surface inductance)(H/m)
- L_e : External inductance (H/m)
- C : Capacitance (F/m)
- G : Conductance (Ω /m)
- f : Frequency (Hz)
- ω : Angular frequency (= $2\pi f$)
- α : Attenuation (Np/m)(INP=8.686 dB)
- α_r : Resistive attenuation (Np/m or dB/m)
- α_g : Cross talk (Np/m or dB/m)
- β : Phase (rad/m)
- γ : Propagation constant (= $\alpha + j\beta$)
- Z_o : Characteristic impedance (Ω)

Electrical Characteristics Calculation Formulations

1) Primary Constants of Coaxial Cables (sine wave AC)

• Basic Formulae

R : Effective Conductor Resistance (Ω/m)

$$R = R_1 + R_2 \quad R_1 = \frac{1}{d_1} \sqrt{\frac{\mu_1 \rho_1 f}{\pi}} \cdot F_R(u_1) + \frac{(d_1 + 3d_1)}{4\pi d_1^2} \cdot \rho_1$$

$$R_2 = \frac{1}{d_2} \sqrt{\frac{\mu_2 \rho_2 f}{\pi}} \cdot F_R(u_2) + \frac{(d_2 + 3d_2)}{4\pi d_2^2} \cdot \rho_2$$

Where $d_1' = d_1 - 2t_1$, $d_2' = d_2 + 2t_2$ However, since $t_1 < d_1$ and $d_1' \approx d_1$, $d_2' \approx d_2$, assume that

$$R_1 = \sqrt{\frac{\mu_1 \rho_1 f}{\pi}} \cdot \frac{F_R(u_1)}{d_1} + \sqrt{\frac{\mu_2 \rho_2 f}{\pi}} \cdot \frac{F_R(u_2)}{d_2} + \left(\frac{\rho_1}{\pi d_1^2} - \frac{\rho_2}{\pi d_2^2} \right)$$

L : Inductance (H/m)

L : $L_e + L_1 + L_2$

$$L_e = \frac{\mu}{2\pi} \ln \frac{d_2}{d_1} = 0.4605 \log_{10} \frac{d_2}{d_1}$$

$$L_1 = \frac{1}{2\pi d_1} \sqrt{\frac{\mu_1 \rho_1}{\pi f}} F_L(u_1)$$

$$L_2 = \frac{1}{2\pi d_2} \sqrt{\frac{\mu_2 \rho_2}{\pi f}} F_L(u_2)$$

G : Conductance (Ω/m)

$$G = \omega C \tan \delta = 2\pi f C \tan \delta$$

C : Capacitance (F/m)

$$C = \frac{2\pi\epsilon}{\ln \frac{d_2}{d_1}} = \frac{24.13 \cdot \epsilon_s}{\log_{10} \frac{d_2}{d_1}} \times 10^{-12}$$

$$\epsilon = \epsilon_s \cdot \epsilon_o$$

where

$$F_R(u) = \frac{\sinh u + \sin u}{\cosh u - \cos u} \quad F_L(u) = \frac{\sinh u + \sin u}{\cosh u - \cos u}$$

$$u_i = t_i \sqrt{\frac{2\omega\mu_i}{\rho_i}} = 2t_i \sqrt{\frac{\pi f \mu_i}{\rho_i}} = 2t_i \sqrt{\pi \rho_i \mu_i} = \frac{2t_i}{\delta_i}$$

σ_i : Conductor conductivity (Siemens/m)

δ_i : Conductor skin thickness (m)

$i = 1, 2$ (inner and outer conductors)

• Approximation Formulas for relatively high frequencies

$F_R(u_i)$, $F_L(u_i) \approx 1$, therefore,

$$R = \frac{1}{d_1} \sqrt{\frac{\mu_1 \rho_1 f}{\pi}} + \frac{1}{d_2} \sqrt{\frac{\mu_2 \rho_2 f}{\pi}} + \left(\frac{\rho_1}{\pi d_1^2} - \frac{\rho_2}{\pi d_2^2} \right)$$

$$L = \frac{\mu}{2\pi} \ln \frac{d_2}{d_1} + \frac{1}{2\pi d_1} \sqrt{\frac{\mu_1 \rho_1}{\pi f}} + \frac{1}{2\pi d_2} \sqrt{\frac{\mu_2 \rho_2}{\pi f}}$$

For higher frequencies

$$R = \frac{1}{d_1} \sqrt{\frac{\mu_1 \rho_1 f}{\pi}} + \frac{1}{d_2} \sqrt{\frac{\mu_2 \rho_2 f}{\pi}}$$

(when d_1 and d_2 are not much less than 1)

$$L = \frac{\mu}{2\pi} \ln \frac{d_2}{d_1}$$

When the inner and outer conductors are stranded annealed copper(non-magnetic) and the inner conductor is a solid conductor without a ferromagnetic insulator.

$$R = 83.04 \sqrt{f} \left\{ \frac{k_1}{d_1} + \frac{k_2}{d_2} F_R(u_2) \right\} \times 10^{-9} + 5.487 \left(\frac{k_1^2}{d_1^2} - \frac{k_2^2}{d_2^2} \right) \times 10^{-9}$$

$$L = 0.4605 \log_{10} \frac{d_2}{d_1} \times 10^{-6} + \frac{13.21}{\sqrt{f}} \left\{ \frac{k_1}{d_1} + \frac{k_2}{d_2} F_R(u_2) \right\} \times 10^{-9}$$

where $\mu_1 = \mu_2 = \mu = \mu_o$ (Non-magnetic material)

$F_R(u_1) = F_L(u_1) = 1$ (Solid internal conductor)

$u_2 = 30.3t_2 \sqrt{f}$ (for stranded annealed copper)

and $\rho_1 = k_1^2 \rho_o$, $\rho_2 = k_2^2 \rho_o$, where k_i is as specified below

$k_i = 1$ (Single copper wire, Copper circular tube)

$k_i = 1.2$ (Stranded wire)

$k_i = 1.3$ (Aluminum Tube)

$k_i = 3.6$ (Lead Tube)

$k_i = 2 \sim 3$ (Braided Copper Wire)

For comparatively high frequencies

$F_R(u_2)$, $F_L(u_2) \approx 1$, therefore,

$$R = 83.04 \sqrt{f} \left\{ \frac{k_1}{d_1} + \frac{k_2}{d_2} \right\} \times 10^{-9} + 5.487 \left(\frac{k_1^2}{d_1^2} - \frac{k_2^2}{d_2^2} \right) \times 10^{-9}$$

$$L = 0.4605 \log_{10} \frac{d_2}{d_1} \times 10^{-6} + \frac{13.21}{\sqrt{f}} \left\{ \frac{k_1}{d_1} + \frac{k_2}{d_2} \right\} \times 10^{-9}$$

For higher frequencies

$$R = 83.04 \sqrt{f} \left\{ \frac{k_1}{d_1} + \frac{k_2}{d_2} \right\} \times 10^{-9}$$

(d_1 and d_2 are not much less than 1)

$$L = 0.4605 \log_{10} \frac{d_2}{d_1} \times 10^{-6}$$

2) Coaxial Cable Secondary Constants (sine wave AC)

Since coaxial cables are used at comparatively high frequencies, usually $\omega L \approx \omega L_e > R$, $\omega C > G$

Accordingly, Z_o : Characteristic impedance Ω is obtained by

$$Z_o = \sqrt{\frac{L}{C}} = j \frac{R}{2\beta}$$

α : Attenuation Np/m

$$\alpha = \alpha_r + \alpha_g \quad \alpha_r = \frac{R}{2\sqrt{L}} \quad \alpha_g = \frac{G}{2\sqrt{C}}$$

Electrical Characteristics Calculation Formulations

β : Phase rad/m

$$\beta = \omega \sqrt{LC} \left\{ 1 + \frac{1}{8} \left(\frac{R}{\omega L} + \frac{G}{\omega C} \right) \right\}$$

For frequencies of more than several tens of kHz

$$Z_o = Z_{\infty} + \Delta Z_o (1-j)$$

$$Z_{\infty} = \frac{60}{\sqrt{\epsilon_s}} \ln \frac{d_2}{d_1} = \frac{138.2}{\sqrt{\epsilon_s}} \log_{10} \frac{d_2}{d_1}$$

$$\Delta Z_o = \frac{1.98}{\sqrt{f} \sqrt{\epsilon_s}} \left(\frac{k_1}{d_1} + \frac{k_2}{d_2} \right)$$

The ΔZ_o item is negligible, if frequency f is higher than several hundred kHz

$$\alpha_r = \frac{\sqrt{10} \sqrt{\epsilon_s} \sqrt{f}}{60 \ln \frac{d_2}{d_1}} \left(\frac{\sqrt{\rho_1}}{d_1} + \frac{\sqrt{\rho_2}}{d_2} \right) \times 10^{-4} \text{ (Np/m)}$$

$$= 0.0629 \sqrt{\epsilon_s} f_m \left(\frac{\sqrt{\rho_1}}{d_1} + \frac{\sqrt{\rho_2}}{d_2} \right) \log_{10} \frac{d_2}{d_1} \text{ (dB/km)}$$

ϵ : Effective Dielectric Constant f_m : MHz

$$\alpha_g = \frac{\pi}{3} \cdot f \cdot \sqrt{\epsilon_s} \cdot \tan \delta \times 10^{-6} \text{ (Np/m)}$$

$$= 90.9 f_m \sqrt{\epsilon_s} \cdot \tan \delta \text{ (dB/m)}$$

$$\beta = 20.94 \cdot f \cdot \sqrt{\epsilon_s} \times 10^9 + \frac{0.301 \sqrt{\epsilon_s}}{\sqrt{f} \cdot \log_{10} \frac{d_2}{d_1}} \left(\frac{k_1}{d_1} + \frac{k_2}{d_2} \right) \times 10^9$$

• Wave length reduction ratio $K = \frac{100}{\sqrt{\epsilon}} (\%)$

3) Coaxial cable composite specific dielectric constant and composite dielectric power factor calculation formulas.

For coaxial insulation

$$\epsilon_s = \frac{\epsilon_A \epsilon_B P}{\epsilon_A R + \epsilon_B Q}$$

$$\tan \delta = \frac{\epsilon_A R \tan \delta_A + \epsilon_B Q \tan \delta_B}{\epsilon_A R + \epsilon_B Q}$$

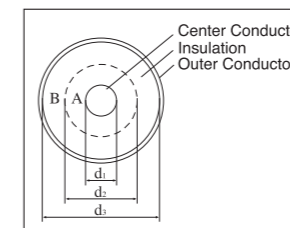

Therefore,

$$P = \ln \frac{d_3}{d_1} \quad Q = \ln \frac{d_2}{d_1} \quad R = \ln \frac{d_3}{d_2}$$

Air-spaced insulation

For circular air-spaced insulation :

Outer diameter of inner conductor : d_1

Inner diameter of outer conductor : d_2

Outer diameter of air-spaced insulation $d_3 = \frac{d_2 - d_1}{2}$

Specific dielectric constant of air-spaced insulation : ϵ_c

Dielectric power factor of air-spaced insulation : $\tan \delta_c$

Winding pitch of air-spaced insulation : P

Therefore

$$\text{Air-space Occupation ratio } d_3 = \frac{d_3}{4d_4} \sqrt{1 + \left(\frac{\pi d_4}{P} \right)^2} = \frac{1}{4} \frac{d_2 + d_1}{d_2 + d_1} \sqrt{1 + \left(\frac{\pi d_4}{P} \right)^2}$$

Where $d_4 = \frac{d_1 - d_2}{2}$

Effective specific dielectric constant $\epsilon_{s3} = 1 + (\epsilon_c - 1)K$,

Effective dielectric power factor $\tan \delta = \frac{\epsilon_c \cdot k \cdot \tan \delta_c}{\epsilon_s}$

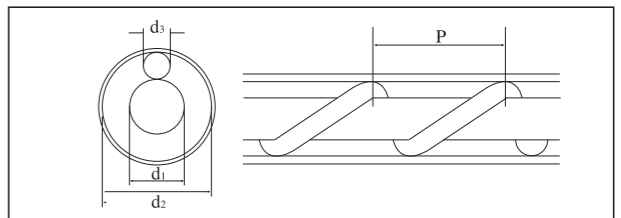

6. Foaming Ratio and Equivalent Specific Dielectric Constant of Cellular Insulation

Effective specific dielectric constant of cellular substance : ϵ_c

Specific dielectric constant of insulator : ϵ_i

Specific dielectric constant of bubbles (air) : ϵ_a ($\epsilon_a = 1$)

Volumetric foaming ratio : F (%)

Then,

$$\frac{\epsilon_c - \epsilon_a}{\epsilon_i - \epsilon_a} = F \cdot \frac{3\epsilon_c}{2\epsilon_c + \epsilon_a} \text{ (A.S. Windeler Formula)}$$

The effective dielectric constant of cellular polyethylene.

The relationship between the effective specific dielectric constant and the volumetric foaming ratio (F) is shown in the following diagram when polyethylene having a specific dielectric constant $\epsilon_i = 2.26$ is used as insulation.

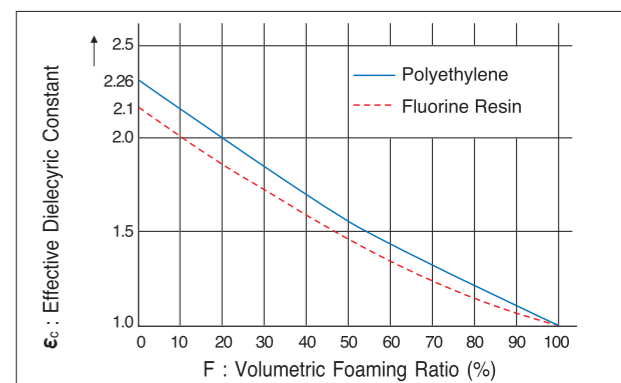

Allowable Current Calculation Formulations

1. Allowable Current Calculation Formulae

$$I = K \sqrt{\frac{T_c - T_a}{\gamma \cdot R_{th}}}$$

$$\gamma = \gamma_0 \{1 + (T_c - 20)\}$$

$$R_{th} = R_1 + R_2$$

$$R_1 = \frac{P_1}{2\pi} \log_e \frac{d_2}{d_1}$$

$$R_2 = \frac{10P_2}{\pi d_2}$$

Table 1
Specific thermal resistance of P₁ insulation

Material	P ₁ (°C · cm/W)
PVC	600
Cross-linked PVC	600
Polyethylene	450
Cross-linked Polyethylene	450
Silicone Rubber	500
Ethylene Propylene Rubber	500
Chloroprene Rubber	500
Teflon (PTFE)	450
Teflon (FEP)	400
E T F E	1,200
Vinylidene Fluoride	1,200

P₂ surface radiation thermal resistance

Material	P ₂ (°C · cm/W)
Materials in the above table	500+10d ₂ (d ₂ ≤ 40)
Impregnated braiding	400+20d ₂ (d ₂ ≤ 20)

- I : Allowable current (A)
- γ : Effective resistance of conductor at T_c of wire (Ω/cm)
- R_{th} : Total thermal resistance (°C cm/w)
- T_c : Maximum allowable temperature of conductor (°C)
- T_a : Ambient temperature (°C)
- K : Diminution rate for multi-wire installations
- γ₀ : Effective wire resistance at 20°C (Ω/cm)
- α : Conductor resistance temperature coefficient
Copper 0.00393 Aluminum 0.0040
- R₁ : Thermal resistance of insulation (°C cm/w)
- R₂ : Wire surface radiation thermal resistance (°C cm/w)
- P₁ : Specific thermal resistance of insulation (°C cm/w)
- P₂ : Surface radiation specific thermal resistance (°C cm/w)
- d₁ : Outer diameter of conductor (mm)
- d₂ : Surface radiation specific thermal resistance (mm)

Table 2
Maximum Allowable Temperature

Material	T _c (°C)
PVC	60
Heat-resistant PVC	75, 80, 90, 105
Cross-linked PVC	105
Polyethylene	75
Cross-linked Polyethylene	90, 105, 125
T F E	250
F E P	200
E T F E	150
Vinylidene fluoride	105
Silicone Rubber	180
Ethylene Propylene Rubber	90

Allowable Current Calculation Formulations

2. Diminution Rate (K)

Allowable current diminution rate for tightly bundled and coiled wires ; (K)

Table 3

No. of Wires	K
1	1.00
2	0.75
3	0.65
4	0.58
5	0.53
6	0.49
7	0.46
8	0.43
9	0.41
10	0.40
11 - 15	0.34
16 - 20	0.30
21 - 30	0.25
31 - 40	0.22
41 - 50	0.20
51 - 60	0.18
61 - 70	0.17
71 - 100	0.16

Allowable current diminution rate for cable tray without spacing

Table 4

No. of Vertical Wires	Number of Rows										
	1	2	3	4	5	6	7	8	9	10	
Number of Tiers	1	1.00	0.80	0.70	0.65	0.62	0.60	0.58	0.57	0.56	0.55
	2	0.70	0.56	0.49	0.45	0.43	0.42	0.41	0.40	0.39	0.38
	3	0.66	0.53	0.46	0.43	0.41	0.40	0.38	0.37	0.36	0.35
	4	0.58	0.46	0.41	0.38	0.36	0.35	0.34	0.33	0.32	0.31
	5	0.45	0.36	0.32	0.29	0.28	0.27	0.26	0.25	0.24	0.23

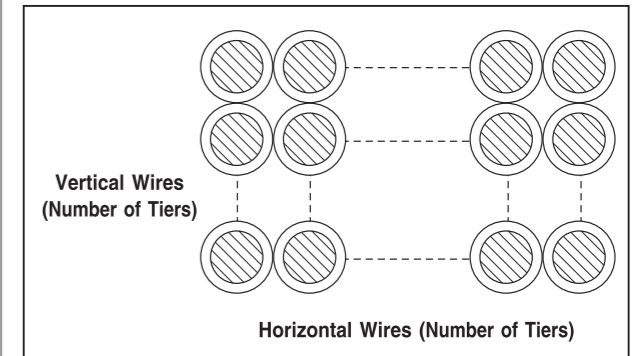

Allowable Current Calculation Formulations

Table 5
Allowable Current for TEW Wire

Conductor			Allowable Current								
Size (AWG)	Nominal Cross-sectional Area(mm ²)	Construction (No./mm)	Conductor Temperature 60°C	Conductor Temperature 75°C	Conductor Temperature 80°C	Conductor Temperature 90°C	Conductor Temperature 105°C	Conductor Temperature 125°C	Conductor Temperature 150°C	Conductor Temperature 200°C	Conductor Temperature 260°C
30	-	1/0.26	1	1	2	2	2	2	2	3	3
28	-	1/0.32	1	2	2	3	3	3	3	4	4
26	-	1/0.40	2	3	3	4	4	4	4	5	6
24	-	1/0.50	3	4	4	5	5	6	6	7	8
22	-	1/0.65	5	6	6	7	8	8	8	10	12
20	-	1/0.80	6	7	8	9	10	11	11	14	15
18	-	1/1.0	9	10	11	12	14	15	16	19	22
16	-	1/1.2	11	13	15	16	17	19	22	26	31
15	-	1/1.4	14	16	18	19	21	23	26	32	38
14	-	1/1.6	17	20	22	24	27	28	30	36	42
30	0.05	7/0.1	1	1	2	2	2	2	2	3	3
28	0.08	7/0.12	1	2	2	3	3	3	3	4	4
26	0.14	7/0.16	2	3	3	4	4	5	5	6	6
-	0.18	7/0.18	3	4	4	5	5	5	6	7	8
24	0.20	7/0.20	3	5	5	6	6	6	8	9	10
22	0.3	12/0.18	4	5	6	7	8	8	9	10	11
20	0.5	19/0.18	7	7	8	9	10	11	11	14	15
-	0.75	30/0.18	9	10	11	12	14	15	16	20	22
18	0.9	37/0.18	10	11	13	14	16	17	19	23	26
16	1.25	50/0.18	12	14	16	17	19	21	22	27	30
14	2	37/0.26	17	20	23	24	27	28	30	37	41
-	3.5	45/0.32	23	27	32	33	35	44	45	56	62
-	5.5	70/0.32	32	38	44	45	48	59	62	77	86

Table 6
Conductor Temperatures are the same as Table 5

Current Correction Factor at Ambient Temperature	30°C	1.22	1.13	1.11	1.09	1.07	1.05	1.04	1.03	1.02	
	40°C	1.00	1.00	1.00	1.00	1.00	1.00	1.00	1.00	1.00	1.00
	50°C	0.70	0.84	0.86	0.89	0.91	0.93	0.95	0.96	0.97	
	60°C	-	0.65	0.70	0.77	0.83	0.87	0.90	0.93	0.95	
	70°C	-	0.37	0.50	0.63	0.73	0.80	0.85	0.90	0.92	
	80°C	-	-	-	0.44	0.62	0.72	0.79	0.86	0.90	
	90°C	-	-	-	-	0.48	0.64	0.73	0.82	0.87	
	100°C	-	-	-	-	0.27	0.54	0.57	0.79	0.85	
	125°C	-	-	-	-	-	-	0.47	0.68	0.78	
	150°C	-	-	-	-	-	-	-	0.55	0.70	
	200°C	-	-	-	-	-	-	-	-	0.52	
	Current Correction Factor Calculation Formula	$\sqrt{\frac{60-TA}{20}}$	$\sqrt{\frac{75-TA}{35}}$	$\sqrt{\frac{80-TA}{40}}$	$\sqrt{\frac{90-TA}{50}}$	$\sqrt{\frac{105-TA}{65}}$	$\sqrt{\frac{125-TA}{85}}$	$\sqrt{\frac{150-TA}{110}}$	$\sqrt{\frac{200-TA}{160}}$	$\sqrt{\frac{260-TA}{220}}$	

AWG ⇔ mm Conversion Table of Wire Gauges

Gauge				Diameter		Cross-sectional Area			Copper Wire Weight (kg/km)
B.W.G.	A.W.G.	S.W.G.	mm.G.	(mil)	(mm)	(CM)	(sq.in)	(mm ²)	
5/0	...	7/0	...	500.0	12.70	250,000	.1964	126.7	1,126
...	12	472.4	12.00	223,162	.1753	113.1	1,005
...	...	6/0	...	464.0	11.79	215,296	.1691	109.1	969.0
...	4/0	460.0	11.68	211,600	.1662	107.2	953.0
4/0	454.0	11.53	206,100	.1619	104.4	928.1
...	...	5/0	...	432.0	10.97	186,624	.1466	94.56	840.6
3/0	425.0	10.80	180,600	.1419	91.52	813.6
...	3/0	409.6	10.40	167,772	.1318	85.03	755.9
...	...	4/0	...	400.0	10.16	160,000	.1257	81.07	720.7
...	10	393.7	10.00	155,000	.1217	78.54	698.2
2/0	380.0	9.652	144,400	.1134	73.17	650.5
...	...	3/0	...	372.0	9.449	138,384	.1087	70.12	623.4
...	2/0	364.8	9.266	133,079	.1045	67.42	599.4
...	9	354.3	9.000	125,528	.09859	63.62	565.6
...	...	2/0	...	348.0	8.839	121,104	.09512	61.36	545.5
0	340.0	8.636	115,600	.09079	58.58	520.8
...	0	324.9	8.254	105,560	.08291	53.49	475.5
...	...	0	...	324.0	8.230	104,976	.08245	53.19	472.8
...	8	315.0	8.000	99,225	.07793	50.27	446.9
1	...	1	...	300.0	7.620	90,000	.07069	45.60	405.4
...	1	289.3	7.343	83,694	.06573	42.41	377.0
2	284.0	7.214	80,660	.06335	40.87	363.0
...	...	2	...	276.0	7.010	76,176	.05983	38.60	343.0
...	7	275.6	7.000	75,955	.05966	38.48	342.1
3	259.0	6.579	67,080	.05269	33.99	302.0
...	2	257.6	6.544	66,358	.05212	33.63	299.0
...	6.5	255.9	6.500	65,485	.05143	33.18	295.0
...	...	3	...	252.0	6.401	63,504	.04988	32.18	286.1
4	238.0	6.045	56,640	.04449	28.70	255.1
...	6.0	236.2	6.000	55,790	.04382	28.27	251.2
...	...	4	...	232.0	5.893	53,824	.04227	27.27	242.4
...	3	229.4	5.827	52,624	.04133	26.66	237.0
5	220.0	5.588	48,400	.03801	24.52	218.0
...	5.5	216.5	5.500	46,872	.03681	23.72	210.9
...	...	5	...	212.0	5.385	44,944	.03530	22.77	202.4
...	4	204.3	5.189	41,738	.03278	21.15	188.0
6	203.0	5.156	41,210	.03237	20.88	185.6
...	5.0	196.9	5.000	38,770	.03045	19.63	174.5
...	...	6	...	192.0	4.877	36,864	.02895	18.68	166.2
...	5	181.9	4.621	33,088	.02599	16.77	149.1
7	180.0	4.572	32,400	.02545	16.42	146.0
...	4.5	177.2	4.500	31,400	.02466	15.90	141.4
...	...	7	...	176.0	4.470	30,976	.02433	15.70	139.6
8	165.0	4.191	27,220	.02138	13.80	122.7
...	6	162.0	4.115	26,244	.02061	13.30	118.2
...	...	8	...	160.0	4.064	25,600	.02011	12.97	115.3
...	4.0	157.5	4.000	24,806	.01948	12.57	111.8
9	148.0	3.759	21,900	.01720	11.10	98.68
...	7	144.3	3.665	20,822	.01635	10.55	93.79
...	...	9	...	144.0	3.658	20,736	.01620	10.52	93.52
...	3.5	137.8	3.500	18,989	.01491	9.621	85.53
10	134.0	3.404	17,920	.01410	9.098	80.88
...	8	128.5	3.264	16,512	.01297	8.368	74.39
...	...	10	...	128.0	3.251	16,384	.01287	8.302	73.81
...	3.2	126.0	3.200	15,876	.01247	8.042	71.49
11	120.0	3.048	14,400	.01131	7.297	64.87
...	...	11	...	116.0	2.946	13,456	.01057	6.818	60.61
...	9	114.4	2.906	13,087	.01028	6.632	58.96
...	2.9	114.2	2.900	13,042	.01024	6.605	58.72
12	109.0	2.769	11,880	.009331	6.020	53.52

AWG ⇔ mm Conversion Table of Wire Gauges

The Following tables compare the main wire gauges used around the world. B.W.G. is an abbreviation for Birmingham (Stub's) Iron Wire Gauge A.W.G. stands for American Wire Gauge (also called Brown & Sharpe Wire Gauge). S.W.G. is abbreviation for British Standard Wire Gauge. "mm.G." represents the millimetric gauge selected by the Wire Standard Survey Subcommittee of the Japan Electric Industrial Committee in November 1921.

Gauge				Diameter		Cross-sectional Area			Copper Wire Weight (kg/km)
B.W.G.	A.W.G.	S.W.G.	mm.G.	(mil)	(mm)	(CM)	(sq.in)	(mm ²)	
...	...	12	...	104.0	2.642	10.816	.008495	5.481	48.73
...	2.6	102.4	2.600	10.486	.008246	5.309	47.29
...	10	101.9	2.588	10.384	.008156	5.262	46.78
13	95.00	2.413	9.025	.007088	4.573	40.65
...	...	13	...	92.00	2.337	8.464	.006648	4.289	38.13
...	11	90.74	2.305	8.234	.006467	4.172	37.09
...	2.3	90.55	2.300	8.199	.006439	4.155	36.94
14	83.00	2.108	6.889	.005411	3.491	31.04
...	12	80.81	2.053	6.530	.005129	3.309	29.42
...	...	14	...	80.00	2.032	6.400	.005027	3.243	28.83
...	2.0	78.74	2.000	6.200	.004869	3.142	27.93
15	...	15	...	72.00	1.829	5.184	.004072	2.627	23.35
...	13	71.96	1.828	5.178	.004067	2.625	23.33
...	1.8	70.87	1.800	5.023	.003945	2.545	22.63
16	65.00	1.651	4.225	.003318	2.141	19.03
...	14	64.08	1.628	4.106	.003225	2.081	18.50
...	...	16	...	64.00	1.626	4.096	.003217	2.075	18.45
...	1.6	62.99	1.600	3.968	.003116	2.011	17.88
17	58.00	1.473	3.364	.002642	1.705	15.16
...	57.07	1.450	3.257	.002558	1.650	14.67
...	...	17	...	56.00	1.422	3.136	.002463	1.589	14.13
...	1.4	55.12	1.400	3.038	.002386	1.539	13.68
...	16	50.82	1.291	2.583	.002029	1.309	11.64
18	49.00	1.245	2.401	.001886	1.217	10.82
...	...	18	...	48.00	1.219	2.304	.001810	1.167	10.38
...	1.2	47.24	1.200	2.232	.001753	1.131	10.06
...	17	45.26	1.150	2.048	.001608	1.037	9.219
19	42.00	1.067	1.764	.001385	0.8938	7.946
...	18	40.30	1.024	1.624	.001275	0.8226	7.313
...	...	19	...	40.00	1.016	1.600	.001257	0.8107	7.207
...	1.0	39.37	1.000	1.550	.001217	0.7854	6.982
...	...	20	...	36.00	0.9144	1.296	.001018	0.6567	5.836
...	19	35.89	0.9116	1.288	.001012	0.6529	5.804
...	0.90	35.43	0.9000	1.255	.0009857	0.6362	5.656
20	35.00	0.8890	1.225	.0009621	0.6207	5.518
...	...	21	...	32.00	0.8128	1.024	.0008042	0.5189	4.613
...	20	31.96	0.8118	1.021	.0008019	0.5174	4.600
...	0.80	31.50	0.8000	992.3	.0007794	0.5027	4.469
...	21	28.46	0.7229	810.0	.0006362	0.4105	3.649
22	...	22	...	28.00	0.7112	784.0	.0006158	0.3973	3.532
...	0.70	27.56	0.7000	759.6	.0005966	0.3848	3.421
...	0.65	25.59	0.6500	654.8	.0005143	0.3318	2.950
...	22	25.35	0.6438	642.6	.0005047	0.3256	2.895
...	25.00	0.6350	625.0	.0004909	0.3167	2.816
23	...	23	...	24.00	0.6096	576.0	.0004524	0.2919	2.595
...	0.60	23.62	0.6000	557.9	.0004382	0.2827	2.513
...	23	22.57	0.5733	509.4	.0004001	0.2581	2.295
24	...	24	...	22.00	0.5588	484.0	.0003801	0.2452	2.180
...	0.55	21.65	0.5500	468.7	.0003681	0.2376	2.112
...	24	20.10	0.5106	404.0	.0003173	0.2047	1.820
...	...	25	...	20.00	0.5080	400.0	.0003142	0.2027	1.802
...	0.50	19.69	0.5000	387.7	.0003045	0.1963	1.745
26	...	26	...	18.00	0.4572	324.0	.0002545	0.1642	1.460
...	17.90	0.4547	320.4	.0002516	0.1623	1.443
...	25	17.72	0.4500	314.0	.0002466	0.1590	1.414
...	...	27	...	16.40	0.4166	269.0	.0002113	0.1363	1.212
...	16.00	0.4064	256.0	.0002011	0.1297	1.153
...	26	15.94	0.4049	254.1	.0001996	0.1288	1.145
...	0.40	15.75	0.4000	248.1	.0001949	0.1257	1.118
...	...	28	...	14.80	0.3759	219.0	.0001720	0.1110	0.9868
...	27	14.20	0.3606	201.6	.0001583	0.1021	0.9077
...	14.00	0.3556	196.0	.0001539	0.09932	0.8830
...	0.35	13.78	0.3500	189.9	.0001491	0.09621	0.8553
...	...	29	...	13.06	0.3454	185.0	.0001453	0.09372	0.8332
29	13.00	0.3302	169.0	.0001327	0.08563	0.7613
...	12.64	0.3211	159.8	.0001255	0.08097	0.7198
...	0.32	12.60	0.3200	158.8	.0001247	0.08042	0.7149
...	...	30	...	12.40	0.3150	153.8	.0001208	0.07791	0.6926
...	12.00	0.3048	144.0	.0001131	0.07297	0.6487
...	...	31	...	11.60	0.2946	134.6	.0001057	0.06818	0.6061

Units Conversion Table

Gauge				Diameter		Cross-sectional Area			Copper Wire Weight (kg/km)
B.W.G.	A.W.G.	S.W.G.	mm.G.	(mil)	(mm)	(CM)	(sq.in)	(mm ²)	
...	0.29	11.42	0.2900	130.4	.0001024	0.06605	0.5872
...	29	11.26	0.2859	126.8	.00009959	0.06425	0.5712
...	...	32	...	10.80	0.2743	116.6	.00009158	0.05913	0.5257
...	0.26	10.24	0.2600	104.9	.00008239	0.05309	0.4720
...	30	10.03	0.2546	100.6	.00007901	0.05097	0.4531
31	...	33	...	10.000	0.2540	100.00	.00007854	0.05067	0.4505
...	...	34	...	9.200	0.2337	84.64	.00006648	0.04289	0.3813
...	0.23	9.055	0.2300	81.99	.00006640	0.04155	0.3694
32	9.000	0.2286	81.02	.00006362	0.04104	0.3649
...	31	8.928	0.2268	79.71	.00006260	0.04039	0.3591
...	...	35	...	8.400	0.2134	70.56	.00005542	0.03575	0.3178
33	8.000	0.2032	64.00	.00005027	0.03243	0.2883
...	32	7.950	0.2019	63.20	.00004964	0.03203	0.2847
...	0.20	7.874	0.2000	62.00	.00004869	0.03142	0.2793
...	...	36	...	7.600	0.1930	57.67	.00004536	0.02927	0.2602
...	0.18	7.087	0.1800	50.23	.00003945	0.02545	0.2263
...	33	7.080	0.1798	50.13	.00003939	0.02540	0.2258
...	7.000	0.1778	49.00	.00003848	0.02483	0.2207
34	...	37	...	6.800	0.1727	46.24	.00003632	0.02343	0.2083
...	34	6.305	0.1601	39.75	.00003122	0.02014	0.1790
...	0.16	6.299	0.1600	39.68	.00003116	0.02011	0.1788
...	...	38	...	6.000	0.1524	36.00	.00002827	0.01824	0.1622
...	35	5.615	0.1426	31.53	.00002476	0.01597	0.1427
...	0.14	5.512	0.1400	30.38	.00002386	0.01539	0.1368
...	...	39	...	5.200	0.1321	27.04	.00002124	0.01370	0.1218
35	36	5.000	0.1270	25.00	.00001963	0.01267	0.1126
...	...	40	0.12	4.800	0.1219	23.04	.00001810	0.01167	0.1037
...	4.724	0.1200	22.32	.00001753	0.01131	0.1006
...	37	4.453	0.1131	19.83	.00001557	0.01005	0.08934
...	...	41	...	4.400	0.1118	19.36	.00001521	0.009817	0.08921
36	...	42	...	4.000	0.1016	16.00	.00001257	0.008107	0.07207
...	38	3.965	0.1007	15.72	.00001235	0.007968	0.07084
...	3.937	0.1000	15.50	.00001217	0.007854	0.06982
...	...	43	0.10	3.600	0.09144	12.96	.00001018	0.006567	0.05838
...	39	3.531	0.08969	12.47	.000009794	0.006319	0.05618
...	...	44	...	3.200	0.08138	10.24	.000008042	0.005189	0.04613
...	40	3.145	0.07937	9.891	.000007768	0.005012	0.04456
...	41	45	...	2.800	0.07113	7.842	.000006159	0.003973	0.03532
...	42	2.494	0.06334	6.219	.000004884	0.003151	0.02801
...	...	46	...	2.400	0.06096	5.760	.000004524	0.002919	0.02595
...	43	2.221	0.05541	4.932	.000003873	0.002499	0.02222
...	...	47	...	2.000	0.05080	4.000	.000003142	0.002027	0.01802
...	44	1.978	0.05023	3.911	.000003072	0.001982	0.01762
...	0.05	1.969	0.05000	3.877	.000003045	0.001963	0.01745
...	45	1.761	0.04473	3.102	.000002436	0.001572	0.01398
...	...	48	...	1.600	0.04064	2.560	.000002011	0.001297	0.01153
...	46	1.568	0.03984	2.460	.000001932	0.001246	0.01108
...	...	47	...	1.397	0.03547	1.951	.000001532	0.0009884	0.008787
...	48	1.244	0.03159	1.547	.000001215	0.0007838	0.006968
...	...	49	...	1.200	0.03048	1.440	.000001131	0.0007297	0.006487
...	49	1.108	0.02813	1.227	.0000009635	0.0006216	0.005526
...	...	50	...	1.000	0.02540	1.000	.0000007854	0.0005067	0.004505
...	50	0.9863	0.02505	0.9728	.0000007641	0.0004929	0.004382

Units Conversion Table

Inch Fraction

Fraction (inches)				mil	mm	Minutes
1/64	15.6	0.397	0.131
...	1/32	31.3	0.794	0.262
3/64	46.9	1.191	0.392
...	...	1/16	...	62.5	1.588	0.524
5/64	78.1	1.985	0.655
...	3/32	93.8	2.381	0.786
7/64	109.4	2.778	0.917
...	1/8	125.0	3.175	1.048
9/64	140.6	3.572	1.179
...	5/32	156.3	3.969	1.310
11/64	171.9	4.366	1.441
...	...	3/16	...	187.5	4.762	1.572
13/64	203.1	5.159	1.703
...	7/32	218.8	5.556	1.834
15/64	234.4	5.953	1.964
...	1/4	250.0	6.350	2.095
17/64	265.6	6.747	2.226
...	9/32	281.3	7.144	2.357
19/64	296.9	7.541	2.488
...	...	5/16	...	312.5	7.937	2.619
21/64	328.1	8.334	2.750
...	1/32	343.8	8.731	2.881
23/64	359.4	9.128	3.012
...	3/8	375.0	9.525	3.143
25/64	390.6	9.922	3.274
...	13/32	406.3	10.319	3.405
27/64	421.9	10.716	3.536
...	...	7/16	...	437.5	11.112	3.667
29/64	453.1	11.509	3.798
...	5/32	468.8	11.906	3.929
31/64	484.4	12.303	4.060
...	1/2	500.0	12.700	4.191

Fraction (inches)				mil	mm	Minutes
33/64	515.6	13.097	4.322
...	17/32	531.3	13.494	4.453
35/64	546.9	13.891	4.584
...	...	9/16	...	562.5	14.287	4.715
37/64	578.1	14.684	4.846
...	19/32	593.8	15.081	4.977
39/64	609.4	15.478	5.108
...	5/8	625.0	15.875	5.239
41/64	640.6	16.272	5.370
...	21/32	656.3	16.668	5.501
43/64	671.9	17.065	5.632
...	...	11/16	...	687.5	17.462	5.762
45/64	703.1	17.859	5.893
...	23/32	718.8	18.256	6.024
47/64	734.4	18.653	6.155
...	3/4	750.0	19.050	6.286
49/64	765.6	19.447	6.417
...	25/32	781.3	19.843	6.548
51/64	796.9	20.240	6.679
...	...	13/16	...	812.5	20.637	6.810
53/64	828.1	21.034	6.941
...	27/32	843.8	21.430	7.072
55/64	859.4	21.828	7.203
...	7/8	875.0	22.224	7.334
57/64	890.5	22.621	7.465
...	29/32	906.3	23.018	7.596
59/64	912.9	23.415	7.727
...	...	15/16	...	937.5	23.812	7.858
61/64	953.1	24.208	7.989
...	31/32	968.8	24.605	8.120
63/64	984.4	25.003	8.251
...	1	1,000.0	25.399	8.382

Length

mm	cm	m	km	inches	feet	yards	chains	miles	nautical miles
3.03030	.303030	.003030	.000003	.119305	.009942	.003314	.000150	.000001	.000001
30.3030	3.03030	.030303	.000030	1.19305	.099421	.033140	.001506	.000018	.000016
303.030	30.3030	.303030	.000303	11.9305	.994211	.331403	.015063	.000188	.000163
1,818.18	181.818	1.81818	.001818	71.5832	5.96527	1.98842	.090382	.001129	.000981
109.090	10,909.0	109.090	.109090	4,294.99	357.916	119.305	5.42297	.067784	.058867
...	392,727	3,927.27	3.92727	154,619	12,884.9	4,294.99	195.227	2.44033	2.11924
1	100000	.001000	.000001	.039370	.003280	.001093	.000049	.000000	.000000
10.000	1	.010000	.000010	.393707	.032808	.010936	.000497	.000006	.000005
1,000.00	100.000	1	.001000	39.3707	3.28089	1.09363	.049710	.000621	.000539
...	100.000	1,000.00	1	39,370.7	3,280.89	1,093.63	497.106	.621382	.539621
25.399525	2,539.9525399	.000025	1	0.83333	.027777	.001262	.000015	.000013	
304.79430	30,479.4304794	.000304	12.0000	1	.333333	.015151	.000189	.000164	
914.38391	91,438.3914383	.000914	36.0000	3.00000	1	.045454	.000568	.000494	
20,116.4	2,011.64	20.1164	0.20116	792.000	66.0000	22.0000	1	.012500	.010855
...	160,931	1,608.31	1.60931	63,360.0	5,280.00	1,760.00	80.0000	1	.868421
...	185,315	1,853.15	1.85315	72,960	6,080.00	2,026.66	92.1212	1.15151	1

Units Conversion Table

Area

sq.m	are	sq.km	sq.in	sq.ft	sq.yd	sq.chain	acre	sq.mile
.000918	.000009	.000000	1.42337	.009884	.000109	.000002	.000000	.000000
.091827	.000918	.000000	142.337	.988457	.109828	.000226	.000022	.000000
3.30582	.033058	.000003	5,124.15	35.5844	3.95382	.008169	.000816	.000001
99.1736	.991736	.000099	153,724	1,067.53	118.614	.245072	.024507	.000038
991.736	9.91736	.000991	...	10,675.3	1,186.14	2.45072	2.45072	.000382
9,917.36	99.1736	.009917	...	106,753	11,861.4	24.5072	24.5071	.003829
...	154.234	15.4234	38,113.6	3,811.36	5.95525
1	.010000	.000001	1,550.05	10.7642	1.19599	.002471	.000247	.000000
100.000	1	.000100	155.055	1,076.42	119.599	.247114	.024711	.000038
...	10,000.0	1	2,471.14	247.114	.386116
.000645	.000006	...	1	.006944	.000771	.000001	.000000	.000000
.092899	.000928	...	144.000	1	.111111	.000229	.000022	.000000
.836097	.008360	.000000	1,296.00	9.00000	1	.002066	.000206	.000000
404.671	4.04671	.000404	627.264	4,356.00	484.000	1	.100000	.000156
4,046.71	40.4671	.004046	...	43,560.0	4,840.00	10.0000	1	.001562
...	25,898.9	2.58989	6,400.00	640.000	1

Volume

cub.cm	cub.m	liters	cub.in	cub.ft	cub.yd	Eng.Gallon	U.S.Gallon
27.8264	.000027	.027826	1.69816	.000982	.000036	.006127	.007351
27,826.4	.027826	27.8265	1,698.16	.932735	.036397	6.12784	7.35137
...	6.01051	6,010.51	366,802	212.259	7.86114	1,323.61	1,587.99
18.0390	.000018	.018039	1.10041	.000637	.000023	.003972	.004765
180.390	.000180	.180390	11.0041	.006370	.000235	.039725	.047656
1,803.90	.001803	1.80390	110.041	.063707	.002359	.397250	.476567
18,039.0	.018039	18.0390	1,100.41	.637077	.023594	3.97250	4.76567
180.390	.180390	180.390	11,004.1	6.37077	.235954	39.7250	47.6567
1	.000001	.001000	.061027	.000035	.000001	.000220	.000264
...	1	1,000.00	61,027.1	35.3165	1.30802	220.216	264.186
1,000.00	.001000	1	61.0271	.035316	.001308	.220216	.264186
16.3870	.000163	.016387	1	.000578	.000021	.003608	.004329
28,316.8	.028316	28.3168	1,728.00	1	.037037	6.23549	7.43051
764.554	.764554	764.554	46,656.0	27.0000	1	168.358	201.974
4,545.96	.004545	4.54596	277.413	.160372	.005939	1	1.2010
3,785.43	.003785	3.78543	231.00	.133680	.004951	.83270	1

Weight

carat	mg	grams	kg	kilo-tons	grains	ounces	pounds	long-tons	short-tons
1.87500	375.000	.375000	.000375	.000000	5.78712	.013227	.000826	.000000	.000000
18.7500	375.000	3.75000	.003750	.000003	57.8712	.132277	.008267	.000003	.000004
1,875.00	375.000	375.000	.375000	.000375	5,787.12	13.2277	.826732	.000369	.000413
18,750.0	...	3,750.00	3.75000	.003750	57,871.2	132.277	8.26732	.003690	.004133
3,000.00	600.000	600.000	.600000	.000600	9,259.30	21.1641	1.32277	.000590	.000661
1	200.000	.200000	.000200	...	3.08640	.007050	.000440	.000000	.000000
.005000	1	.001000	.000001015432	.000035	.000002	.000000	.000000
5.00000	1,000.00	1	.001000	.000001	15.4320	.035273	.002204	.000000	.000001
5,000.00	...	1,000.00	1	.001000	15,432.0	35.2739	2.20462	.000984	.001102
...	1,000.00	1	...	35,273.9	2,204.62	.984205	1.10230
.323994	64.7988	.064798	.000064	...	1	.002285	.000142	.000000	.000000
141.747	28,349.5	28.3495	.028349	.000028	437.500	1	.062500	.000027	.000031
2,267.96	453.592	453.592	.453592	.000453	7,000.00	16.0000	1	.000446	.000500
...	1,016.04	1.01604	...	35,840.0	2,240.00	1	1.12000
...	907.178	.907178	...	32,000.0	2,000.00	.892857	1

Global Network



Overseas Branches

■ China Office

Beijing

East of Jing-jin, Express Yixingbu Toll Gate
Road Dongsanhuan Beilu, Chaoyang District,
Beijing 100027, China
Tel : +86-10-6467-2479, 2482, 2487(800-806)
Fax : +86-10-6467-3435

Shanghai

Room I&J, Floor 11, Huamin Empire Plaza,
No.726, West Yan'an Road, Shanghai, 200050, China
Tel : +86-10-5237-3399, 8997
Fax : +86-10-5237-8996

■ Japan Office

Higashi-kan 16F, Akasaka Twin Tower 17-22, 2-Chome
Akasaka, Minato-Ku Tokyo, Japan
Tel : +81-3-3582-9129 Fax : +81-3-3582-7363

■ Singapore Office

371 Beach Road #13-10 Keypoint Singapore 199597
Tel : +65-6342-9162-3 Fax : +65-6342-9164

■ UAE Office

Capricorn Tower, Office No. 502
Sheikh Zayed Road, P.O.Box 113798 Dubai, UAE
Tel : +971-4-332-9445 Fax : +971-4-332-9446

■ Russia Office

Park Place Moscow, 113/1, Leninsky Prospect,
E-711, Moscow, Russia 117198
Tel : +7-095-956-5814 Fax : +7-095-956-5811

■ USA Office

920 Sylvan Avenue, Englewood Cliffs,
NJ 07632
Tel : +1-201-816-2253 Fax : +1-201-816-2984

Overseas Subsidiaries

■ LS Cable (Wuxi) Ltd. : Wuxi, China

LS Industrial Park, Xin Mei Road,
Hi-Tech New Development zone, Wuxi 214028, China
Tel : +86-510-534-2108 Fax : +86-510-534-5341

■ LS-VINA

So Dau Precint, Hong Bang District,
HaiPhong City, Vietnam
Tel : +84-31-540330, 824968, 824967 Fax : +84-31-824969

■ VINA-LSC

1 Nui Truc Lane, Giang Van Street, Ba Dinh, Hanoi, Vietnam
Tel : +84-4-722-3838, 3535 Fax : +84-4-722-3030

Contact



Anyang Office

555 Hogye-dong, Dongan-gu, Anyang, Kyungki-do, 431-831, Korea
Tel : 82-31-428-4285~8 Fax : 82-31-428-4161
E_mail : jsspark@lscable.com

www.lscable.com

Head Office

19F ASEM Tower, 159 Samsung-dong,
Gangnam-gu, Seoul, 135-090, Korea
Tel : 82-2-2189-9383 & 9386
Fax : 82-2-2189-9399
E_mail : yshwang@lscable.com
yjshin@lscable.com

Busan Office

140-9 Kamjun-2dong, Sasang-gu, Busan,
617-052 ,Korea
Tel : 82-51-310-6763
Fax : 82-51-310-6751
E_mail : chjin@lscable.com

Daegu Office

9-10 Dongmun-dong, jung-gu, Daegu,
700-180, Korea
Tel : 82-53-420-2810
Fax : 82-53-420-2801
E_mail : choilje@lscable.com